

Pilot operating pressure regulator

Reval 182



Reval 182 is pilot-controlled pressure regulator for medium and low pressure applications.

This regulator is suitable for use with previously filtered, non-corrosive gases.

Scan this QR code with your mobile to get more info!



MAIN FEATURES:

- **Top Entry Design for ease of maintenance**
- **Pilot Operated Regulator for low and medium pressure**
- **“Fail Closed” design**
- Inlet Pressure Range: **7 to 275.5 PSIG**
- Ratings: **ANSI 150**
- Connections: **RF**
- Body Materials: **Ductile Iron and Cast Steel**
- Sizes: **1”, 2”, 3”, 4”, 6”, & 8”**
- Flow Coefficient (Nat. Gas): **Cg range 575 to 36,525**
- Minimum Differential **1.25 PSIG**
- Outlet Pressure Range: **3” w.c. to 174 PSIG**
(depending on Installed Pilot)

OPTIONS:

- SB 82 – Integral Slam-Shut valve
- PM 182 – Integral Pilot Operated “Fail to Close” Monitor
- DB 182 – Integral Silencer

Distributed By



Meter, Valve & Control
877-566-3837

**DESIGNED
WITH YOUR
NEEDS IN MIND**

- COMPACT DESIGN
- OUTSTANDING TURN DOWN RATIO
- EASY MAINTENANCE
- HIGH ACCURACY
- TOP ENTRY
- LOW OPERATION COST
- LOW NOISE
- VERY LOW OPERATING ΔP







Fiorentini USA
4555 South Berkeley Lake Road
Norcross, GA 30071
Toll - Free: 888.618.8787
Fax: 770.448.7312
www.fioussa.com

Pietro Fiorentini S.p.A.
via E.Fermi 8/10
I-36057 Arcugnano (VI) Italy
Tel: +39 0444 968.511
Fax: +39 0444 960.468
www.fiorentini.com

Pilot operating pressure regulator

Reval 182

-  Inlet Pressure
-  Outlet Pressure
-  Motorization
-  Motorization Monitor
-  Pilot Feed

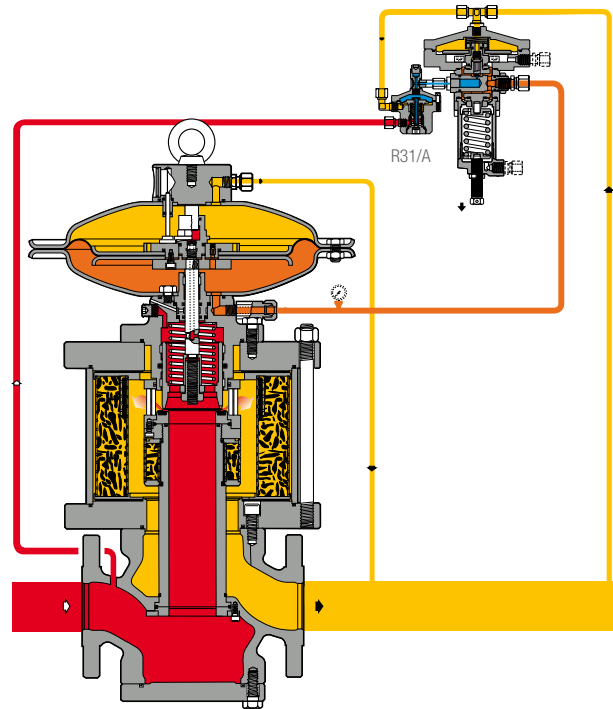

201/A
0,007 ÷ 0,68 bar
2,8 w.c. ÷ 8,4 psig

204/A
0,3 ÷ 12 bar
4,35 ÷ 174 psig

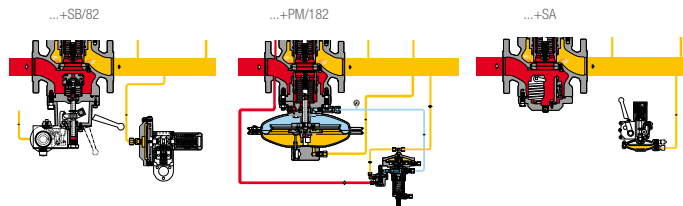

Reval 182 pressure regulator in action



Florentini USA **Toll - Free: 888.618.8787** Fax: 770.448.7312 www.fiousa.com

Pietro Fiorentini **Tel: +39 0444 968.511** Fax: +39 0444 960.468 www.fiorentini.com

| sales@mvandc.com | Phone: 877.566.3837 | Fax: 925.407.2903