

# DOMINO

## For chemical liquids

Distributed By



Meter, Valve & Control  
877-566-3837

### Applications

Flow measurement of liquids in chemical, chemotechnical, pharmaceutical, cosmetic and other industries.  
Batching and filling operations.



### Features

- Product versions for safe areas or for hazardous areas (ATEX)
- Modular products with wide range of flow sensors, displays, pulsers and batching controls
- Mechanical, pneumatic and electronic batching controls

### Your Benefits

- Highly flexible mounting with least space requirements
- Suitable for both conductive and non conductive liquids
- Flow disturbances do not influence proper operation and accuracy
- Long life with low maintenance

# DOMINO - the modular flow measurement concept

## System overview

Page 4

### ARD rotary piston flowmeters for 15...30.000 l/h



- Nominal diameter DN 15, 20, 25, 40 and 50 mm
- Operating pressures PN 10, 16, 25 or 40
- Fluid temperatures up to 180 °C
- Modular meter concept in various materials
- Measuring error limits  $\pm 0,5$  % of effective value
- For high viscosity range up to about 10.000 mPa·s
- Swivelling roller register for optimal readability
- Special-purpose calibrations for differential pressure measurement (optional)
- All flowmeters available with various modules according to need

Page 9

### AMD vane wheel flowmeters for 140...12.000 l/h



- Nominal diameter DN 25 and 40 with flanged connections
- Operating pressure PN 25
- Fluid temperatures up to 90 °C, special versions up to 180 °C
- For low viscosity range up to 4 mPa·s
- Measuring error limits  $\pm 2$  % of effective value ( $\pm 5$  % at lower end of measuring range)
- All flowmeters available with various modules according to need

Page 15

### PMD vane wheel flowmeters for 100...20.000 l/h



- Nominal diameter DN 20, 25 and 40 with threaded connections
- Operating pressure PN 16
- Fluid temperatures up to 90 °C
- Primarily for water, also for non-aggressive low-viscosity fluids up to 4 mPa·s
- Measuring error limits  $\pm 2$  % of effective value ( $\pm 5$  % at lower end of measuring range)
- All flowmeters available with various modules according to need

Page 18

## **VZTH 8 rotary piston flowmeter for 5...150 l/h**

In addition to the DOMINO range, a flowmeter is also available for lower flows. For detailed technical data, please see our separate Technical Documentation.

<b>Pulsers</b>	<b>Page 20</b>
<b>System planning</b>	<b>Page 21</b>
<b>Ordering information</b>	<b>Page 23</b>
<b>Accreditations</b>	<b>Page 28</b>

# System overview

## Meter Ancillaries

- display in volumetric units (litre or m<sup>3</sup>), special version with display in US-Gallons available
- with pulser, roller counter or for batching devices

### RW

- Roller register
- local totalization

### RV

- Roller register with integral reed-type pulser
- local totalizing
  - pulser for remote totalizing
  - not for use in hazardous areas!

### IN

- Inductive pulser for industrial control systems
- to IEC 60947-5-6
  - 2 different resolutions
  - for hazardous location Zone 1 (ATEX version)
  - roller register

### INA

- Inductive pulser for industrial control systems
- to IEC 60947-5-6
  - high resolution for analogue signal generation or input to electronic batching controls
  - for hazardous location Zone 1 (ATEX version)
  - optional roller register

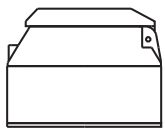

565569

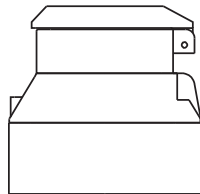

AM066133

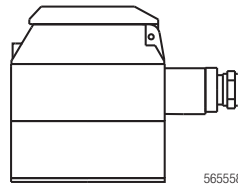

565558

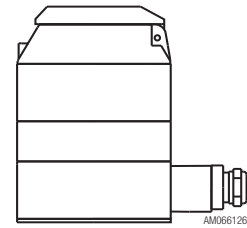

AM066126

## Measuring Units

- different measuring principles (ARD, AMD and PMD)
- various materials according to the meter type (stainless steel, cast iron, brass, PTFE plastics)
- flanges according to DIN (in general also available with ANSI or JIS borings)

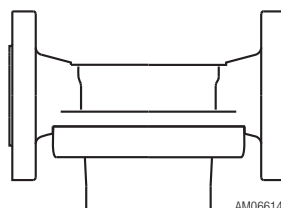

AM066146

### ARD Rotary Piston Meters for chemical liquids

Nominal diameter	15, 20, 25, 40, 50 mm
Nominal pressure	10, 16, 25, 40 bar
Temperature	40, 50, 90, 130, 180 °C
Flow rate	10 - 30'000 l/h

## Accessories

- batching devices for manual, semi-automatic and automatic control

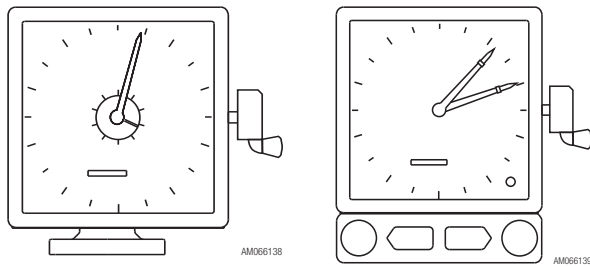

### GTAS module

Intermediate drive for AS or ASP batching control

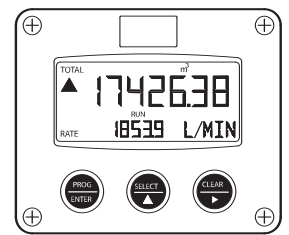

### MS-KP

Mounting set for compact mounting F131

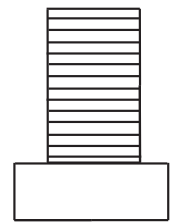

### INA module

Pulsar for electrical batching units

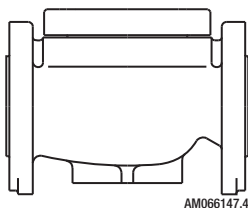
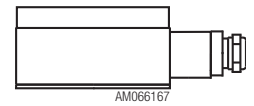
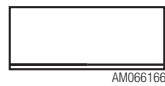

### AMD Vane Wheel Meters for chemical liquids

Nominal diameter	25, 40 mm
Nominal pressure	16, 25 bar
Temperature	90, 180 °C
Flow rate	140 - 12'000 l/h

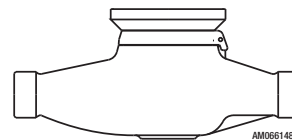

### PMD Vane Wheel Meters for cold and hot water / batching

Nominal diameter	20, 25, 40 mm
Nominal pressure	16 bar
Temperature	90 °C
Flow rate	100 - 20'000 l/h

## Applications

- ARD rotary piston flowmeters for pure chemical liquids of various types
- AMD vane wheel flowmeters for chemical liquids
- PMD vane wheel flowmeters for water (in particular for dosing)

## Selection of commonly measured liquids

### Acetic acid

Acetone

Animal fats

Ammonium hydroxide, ammonia solution

### Bromine hydroxide, bromic acid

Butyl acetate, acetic butyl ester

### Chloroform, trichloromethane

Citric acid

### Diethylene glycol

Distilled water

### Ethyl acetate, acetic ether, acetic ester

Ethyl alcohol, alcohol, ethanol

Ethyl ethylene, ethylene, diethyl ethylene

Ethylene glycol

### Formaldehyde solution

Formic acid

### Glycerine

### Hexane

Hydrochloric acid

Hydrofluoric acid

Hydrogen peroxide, hydrogen superoxide

### Isopropyl ether, di-isopropyl ether

Isopropyl alcohol, propyl alcohol

### Kerosene, petroleum

### Liquid ammonia

Liquid bromine

Liquid butane

### Magnesium sulphate

Methanol, methyl alcohol

Methylene chloride, dichloromethylene

Methyl ethyl ketone

Molasses (without urea)

### Nitric acid

### Paraffin

Perchloroethylene, tetrachloroethylene

Phosphoric acid

Potassium hydroxide, caustic potash

Propionic acid

Prussic acid

Pure benzol

### Sodium chloride solution, brine

Sodium hydroxide, caustic soda solution

Sodium hypochlorite solution, Javelle water

Sulfocarbonic acid

Sulphuric acid

### Tar, pitch

Tetrachloromethane, carbon tetrachloride

Toluene

Trichloroethylene (dry)

### Vegetable oils

## Operation principles

### ARD range

- Works on the volumetric principle with rotary pistons
- Wide measuring range with high precision
- Suitable for high viscosities
- Insensitive to flow disturbances
- No power supply needed

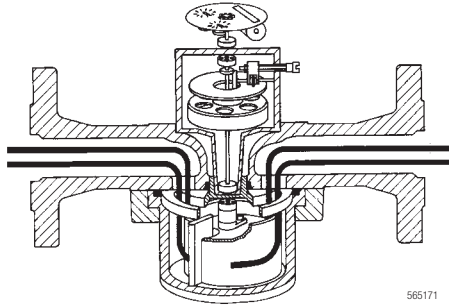

### AMD and PMD series

- Works on the velocity measuring principle with multi-jet vane wheel
- Extremely wide measuring range with good accuracy
- Largely insensitive to slight impurities in liquid media
- Insensitive to flow disturbances
- No power supply needed

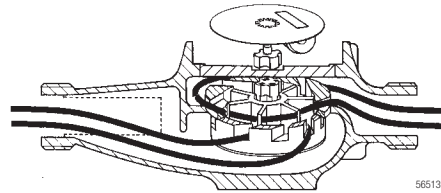

## Design features

### ARD range

- The only moving parts in contact with the liquid medium are the rotary piston, guide rollers and carrier. The hydraulic measuring module is completely isolated from the roller register, and signals are transmitted magnetically through the sealed cover of the measuring chamber.
- For optimal readability, the roller register can be swivelled through 360° on versions without RV integral pulser.

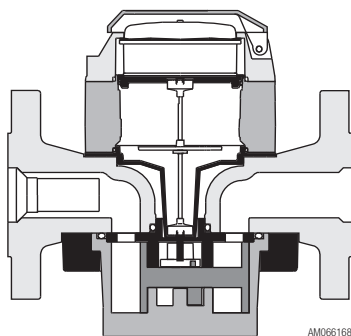

### AMD and PMD series

- The only moving part in contact with the liquid medium is the vane-wheel. In AMD models this is mounted between PTFE bearings, and in PMD models on ruby bearings. This ensures years of easy running and high precision, long life and excellent long-term stability of the measuring characteristic.
- The hydraulic measuring module is completely isolated from the roller register, and signals are transmitted magnetically through the sealed cover of the measuring chamber.
- For optimal readability, the roller register can be swivelled through 360° on versions without RV integral pulser.

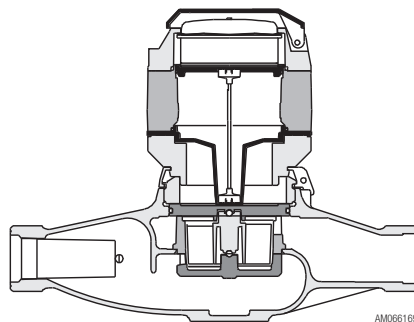

## Permissible measuring error under reference conditions

### ARD rotary piston flowmeters

Reference conditions:

	Group A	Group B	Group A comprises the flowmeter with rotary pistons of vulcanized rubber, graphite or PTFE. Group B has rotary pistons of aluminium or stainless steel.
Medium:	Water	calibration oil (5 mPa·s at 20 °C)	
Temperature:	20 °C	18...25 °C	

Horizontal meter mounting, reading on register

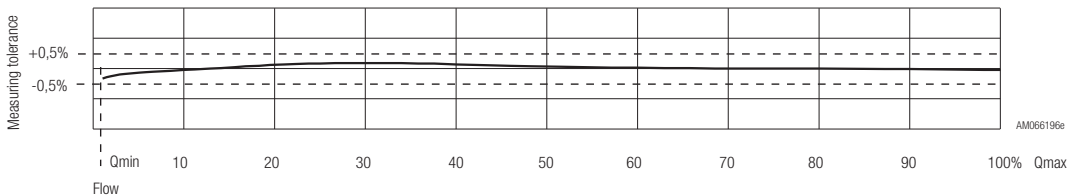

DOMINO ARD rotary piston flowmeters have an infinitely adjustable regulation mechanism for correcting the measuring error curve. So if necessary the measuring tolerance can be set to practically zero at constant flow either on site or by special works calibration.

### AMD and PMD vane wheel flowmeters

Reference conditions:

Medium:	Water
Temperature:	20° C

Horizontal meter mounting, reading on register

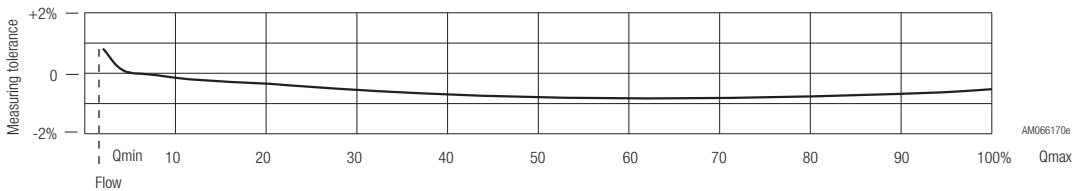



# DOMINO ARD rotary piston flowmeters

## Technical data



- For chemical liquids with viscosities up to about 10 000 mPa·s
- For horizontal or vertical installation
- Measuring error limits  $\pm 0.5\%$  of effective value, repeatability  $\pm 0.1\%$   
Max. temperature 40, 50, 90, 130 or 190 °C (according to version)
- Max. pressure 10, 16, 25 or 40 bar (according to version)
- Threaded connections (brass housing)
- Combinable with all DOMINO modules
- Special versions with units of measurement in US gallons or with different flange-standards (JIS, ANSI) on request

Nominal diameter	DN	mm	15	20	25	40	50
		inch	1/2	3/4	1	1 1/2	2
Overall length		mm	165	165	190 <sup>1)</sup>	300	350
Rated max. pressure with threaded connections							
ARD 1000		bar	16	16	16	16	16
Rated max. pressure with flanged connections							
ARD 1000		bar	25	25	25	25	25
ARD 2000		bar	40	40	40	40	40
ARD 3000		bar	25	25	25	25	25
ARD 4000		bar	10	10	10	10	10
Maximum flow rate <sup>2)</sup>	Q <sub>max</sub>	l/h	400	1500	3000	9000	30000
Flow in batching mode	Q <sub>ch</sub>	l/h	320	1200	2400	7200	24000
<b>Continuous flow rate <sup>2)</sup></b>	<b>Q<sub>n</sub></b>	<b>l/h</b>	<b>200</b>	<b>750</b>	<b>1500</b>	<b>4500</b>	<b>15000</b>
Minimal flow rate <sup>3)</sup>	Q <sub>min</sub>	l/h	15	30	75	225	750
Starting flow rate approx. <sup>3)</sup>		l/h	6	12	30	90	300
Smallest registered value <sup>4)</sup>		l	0.01	0.1	0.1	0.1	1
Metering capacity <sup>4)</sup>		m <sup>3</sup> /h	1000	10000	10000	10000	100000
Metering time at Q <sub>n</sub> without overflow <sup>4)</sup>		h	5000	13333	6666	2222	6666
Safety filter mesh size		mm	0.4	0.4	0.4	0.8	0.8
Dirt trap filter mesh size		mm	0.1	0.1	0.25	0.25	0.25
Measuring chamber volume		cm <sup>3</sup>	12	36	100	330	1200
Housing finish		enamelled yellow RAL 1007					
Weight <sup>5)</sup>							
ARD 1000	threaded	kg	2.20	2.50	4.20	17.32	40.00
ARD 1000	flanged	kg	3.80	4.50	7.10	20.27	42.00
ARD 2000	flanged	kg	4.37	5.48	7.60	19.10	42.00
ARD 3000	flanged	kg	4.65	5.80	8.35	20.47	53.00
ARD 4000	flanged	kg	-	-	8.85	20.24	-

1) Overall length with PTFE housing is 260 mm.

2) Flowrates for heating oil are higher. For particular data see Technical Documentation CONTOLIL® oil flowmeter.

3) Q<sub>min</sub> and starting flowrates are valid for material combination: brass housing / aluminium pistons for EL heating oil. Q<sub>min</sub> for other material combination see table below:  
"Measuring range as a function of material combination".

4) For roller register.

5) Meter weight depends on material combinations and modules. Data given are typical for meters with roller register.

## Measuring range as a function of material combination

Q<sub>min</sub> in % of Q<sub>max</sub> with measuring error limits  $\pm 0.5\%$ .

Type	Measuring chamber	Rotary piston				
		Aluminium	Hard rubber	Graphite	Stainless steel	PTFE
ARD 1000	Brass	2.5 %	5 %	5 %	-	10 %
ARD 2000	Stainless steel	2.5 %	-	5 %	5 %	10 %
ARD 3000	Stainless steel	-	5 %	5 %	5 %	10 %
ARD 4000	PTFE	-	-	-	-	10 %

## Measuring sensors and materials

Type	Component	Material
ARD 1000	Housing	Brass (threaded connections) or spherulitic cast iron (threaded or flanged connections)
	Measuring chamber	Brass / PPS (130 °C) or brass / PTFE (180 °C)
	Seals	FPM (fluoroelastomer)
	Rotary pistons	Aluminium, hard rubber, graphite or PTFE
ARD 2000	Housing	Spherulitic cast iron
	Measuring chamber	Stainless steel* / PPS (130 °C) or stainless steel* / PTFE (180 °C)
	Seals	FPM or PTFE (fluoroelastomer or polytetrafluoroethylene)
	Rotary pistons	Hard rubber, graphite, stainless steel* or PTFE
ARD 3000	Housing	Stainless steel*
	Measuring chamber	Stainless steel* / PTFE
	Seals	FPM or PTFE (fluoroelastomer or polytetrafluoroethylene)
	Rotary pistons	Hard rubber, graphite, stainless steel* or PTFE
ARD 4000	Housing	PTFE with metal sleeving
	Measuring chamber	PTFE / Tantal with metal sleeving
	Seals	FFKM (Perfluoroelastomer)
	Rotary pistons	PTFE

\* Corrosion and acid-resistant steel (CrNiMo) to DIN 1.4408 / 1.4435 / 1.4404

# Pressure drop curves

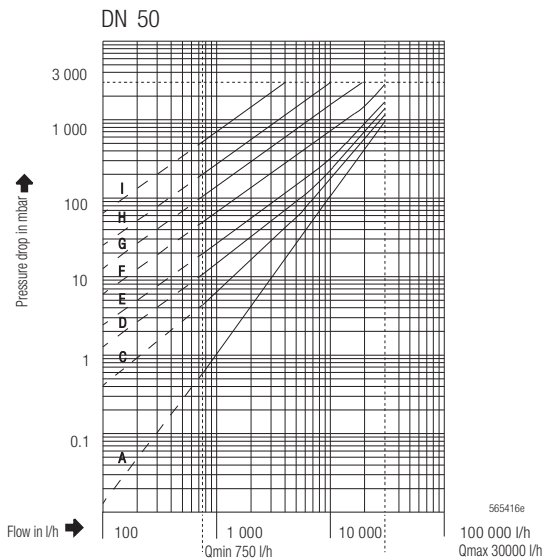
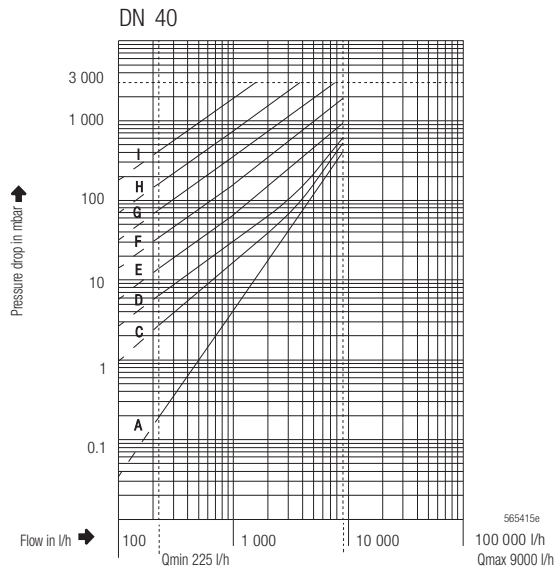
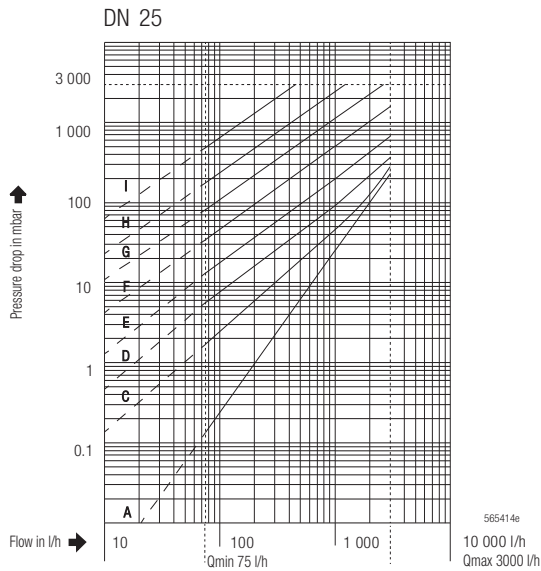
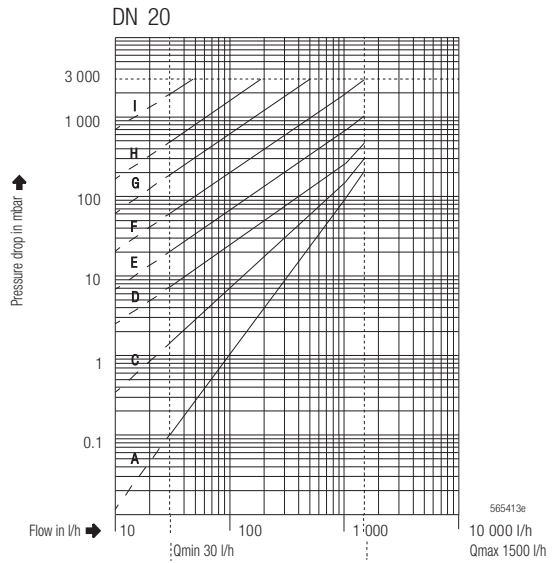
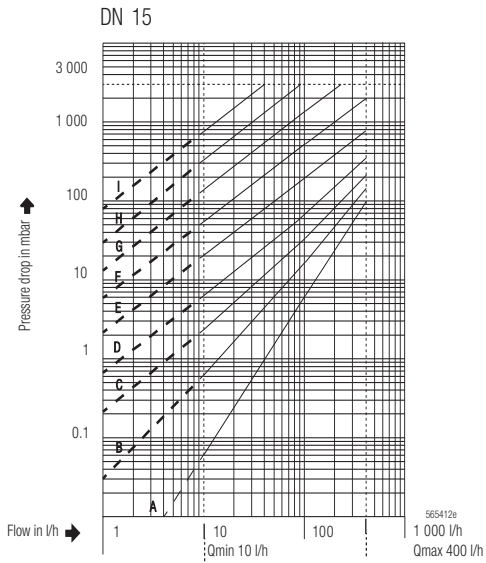

Recommended pressure drop max. 1 bar  
Admissible pressure drop max. 3 bar

Viscosities:

- A = 4.5 mPa·s
- B = 25 mPa·s
- C = 50 mPa·s
- D = 100 mPa·s
- E = 200 mPa·s
- F = 500 mPa·s
- G = 1000 mPa·s
- H = 2000 mPa·s
- I = 5000 mPa·s

## Flowmeter unit dimensions in mm

### ARD 1000 with threaded connections

DN 15, 20, 25

DN 40, 50

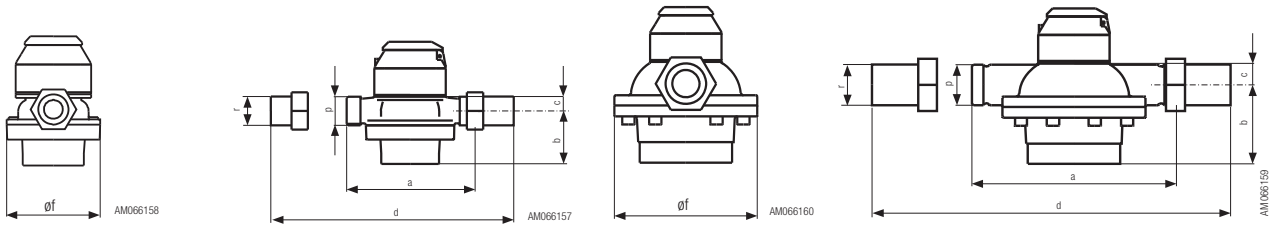

### ARD 1000, 2000, 3000 with flanged connections (to DIN 2501)

DN 15, 20, 25

DN 40, 50

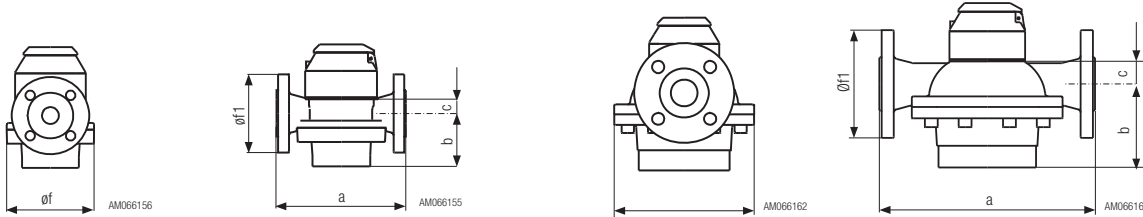

	DN	a	b	c	d	Øf	Øf1	p	r
ARD 15	15	165	42	17	260	105	95	G 3/4"	G 1/2"
ARD 20	20	165	54	17	260	105	105	G 1"	G 3/4"
ARD 25	25	190	78	21	305	130	115	G 1 1/4"	G 1"
ARD 40	40	300	116	32	440	210	150	G 2"	G 1 1/2"
ARD 50	50	350	166	38	510	280	165	G 2 3/8"	G 2"

### ARD 4000 with flanged connections (to DIN 2501 / SN 21843)

DN 25

DN 40

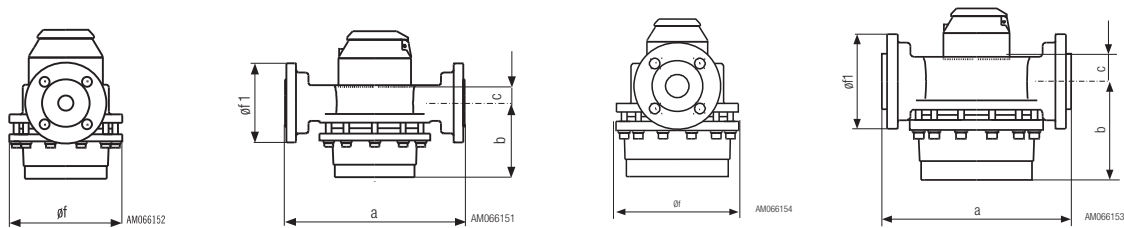

	DN	a	b	c	Øf	Øf1
ARD 25	25	260	107	23	160	115
ARD 40	40	300	157	35	212	150

## RW, RV roller registers and dials

RW  
roller register only  
max. 180 °C

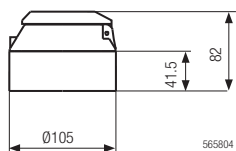

RV  
with integrated pulser (reed type)  
max. 180 °C

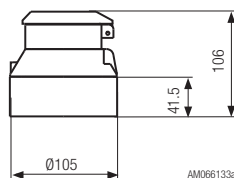

Dials  
DN 15

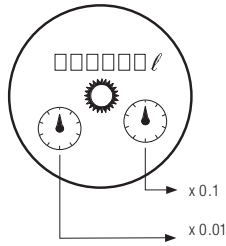

DN 20, 25, 40

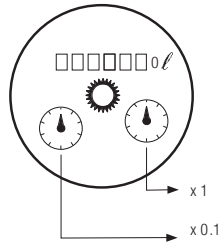

DN 50

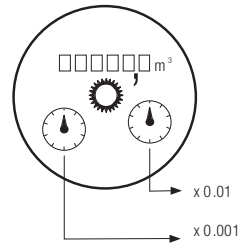

AM066017

## Pulsers

### Technical data

For further technical data and wiring diagrammes, see sections "Pulsers" (page 20) and "Remote pulse transmission" (page 22).

### Pulse values

Pulser type	Nominal diameter of measuring unit					
	mm	15	20	25	40	50
IN Inductive switch (NAMUR)	inch	1/2	3/4	1	1 1/2	2
IN Inductive switch (NAMUR) <sup>1)</sup>	l/pulse	0.01	0.01	0.1	0.1	1
IN Inductive switch (NAMUR) <sup>1)</sup>	l/pulse	0.1	0.1	1	1	10
INA Inductive switch (NAMUR) <sup>1) 2)</sup>	approx. l/pulse	0.0006	0.00185	0.005	0.017	0.06
RV Reed switch	l/pulse	0.1	1	1	1	10
	l/pulse	1	10	10	10	100

1) High temperature versions are designated with H.

2) The exact pulse value is indicated on the meter. Since this value is not known before calibration, the connected unit must have an adaptable input. Versions with 2 pulsers on request.

### Pulse frequencies

IN	at Qmax	Hz	11.111	41.667	8.333	25.000	8.333
IN	at Qmin	Hz	0.278	0.833	0.208	0.625	0.208
INA	at Qmax	Hz	185.185	225.225	166.667	147.059	138.889
INA	at Qmin	Hz	4.630	4.505	4.167	3.676	3.472

### IN / INH

Inductive pulser according to IEC 60947-5-6 (NAMUR) with roller register.

IN  
max. 130 °C

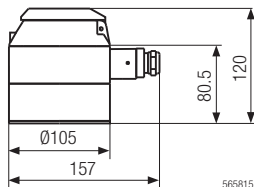

INH  
max. 180 °C

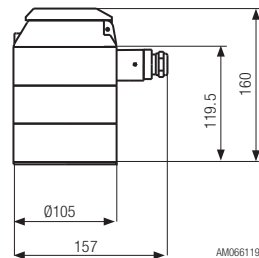

**INA / INAH**

Inductive pulser according to IEC 60947-5-6 (NAMUR) with high resolution.

INA  
without RW (roller register)  
max. 90 °C

INAH  
without RW (roller register)  
max. 180 °C

INA-RW  
with RW (roller register)  
max. 90 °C

INAH-RW  
with RW (roller register)  
max. 180 °C

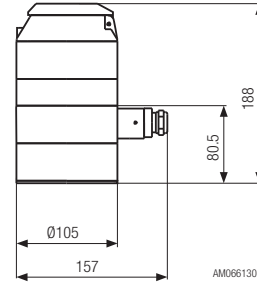
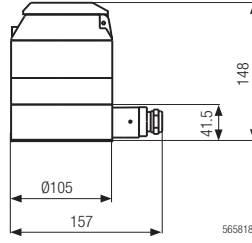
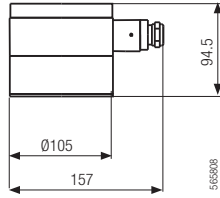
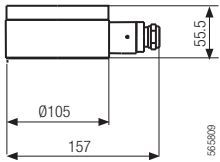

**AS / ASP mechanical batching controls**

GTAS module  
for AS / ASP  
max. 180 °C

GTAS with dosing control (optional)  
with AS 110, 120  
max. 180 °C

all other AS  
max. 180 °C

with ASP  
max. 180 °C

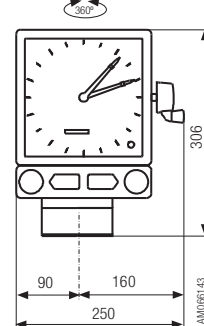
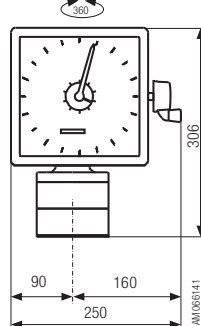
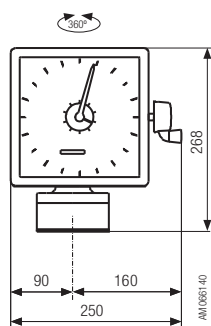
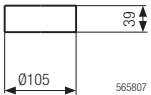

For technical data on AS / ASP batching control modules see separate Technical Documentation.

**Options for external electronic batching controls**

max. 90 °C  
max. 180 °C

INA / RD.. recommended (others also possible)  
INAH / RD.. recommended (others also possible)

Wall or front panel mounting



**ATEX Directive**

With the exception of the - RV ... - ancillary groups, all DOMINO components are certified according to ATEX Directive 94/9/EC.

Marking: II2G cT6

The EC-Type-Examination Certificate is available on our website.

# DOMINO AMD vane wheel flowmeters

## Technical data



- For chemical liquids with viscosities up to about 4 mPa·s
- For horizontal installation - dial upward
- Measuring error limits  $\pm 2\%$  of effective value <sup>1)</sup>, repeatability  $\pm 0.3\%$
- Temperature 90 °C, 180 °C
- Rated pressure PN 25
- Housing with flanged connections to DIN 2501 / SN 218643
- Combinable with all DOMINO modules
- Special versions with other flange holes on request

Nominal diameter	DN	mm	25	40
		inch	1	1 1/2
Overall length		mm	165	300
Rated pressure PN		bar	25	25
Max. temperature	T <sub>max</sub>	°C	90 resp. 180	90 resp. 180
Maximum flow rate	Q <sub>max</sub>	l/h	5000	12000
<b>Continuous flow rate</b>	<b>Q<sub>n</sub></b>	<b>l/h</b>	<b>3500</b>	<b>10000</b>
Transitional flow rate	Q <sub>t</sub>	l/h	280	800
Minimal flow rate	Q <sub>min</sub>	l/h	140	400
With AS 110 filling control:				
Transitional flow rate	Q <sub>t</sub>	l/h	350	1000
Minimal flow rate	Q <sub>min</sub>	l/h	210	600
Smallest registered value		l	0.1	0.1
Metering capacity		m <sup>3</sup> /h	100000	100000
Metering time at Q <sub>n</sub> without overflow		h	28500	10000
Safety filter mesh size in meter base		mm	2.5	2.5
Housing finish			enamelled yellow RAL 1007	
Weight		kg	7.20	14.20

1)  $\pm 5\%$  at lower end of measuring range between Q<sub>min</sub> and Q<sub>t</sub>.

## Measuring module materials

Component	Materials
Housing	Stainless steel*
Measuring unit	Stainless steel*
Seals	PTFE
Vane wheel bearings	PTFE (90 °C), graphite (180 °C)

\* Corrosion and acid-resistant steel (CrNiMo) to DIN 1.4408 / 1.44354

## Pressure drop characteristics

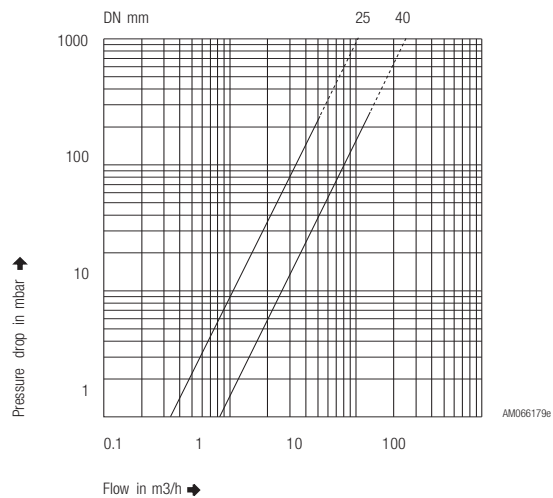

## Measuring module dimensions in mm

### AMD

DN 25

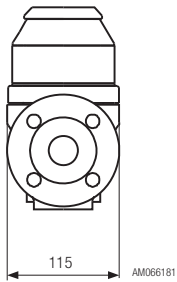

Flanges to DIN 2501 / SN 21843

DN 40

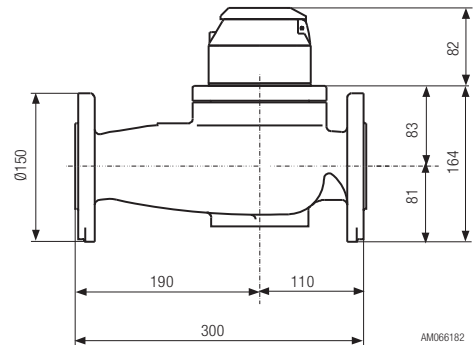
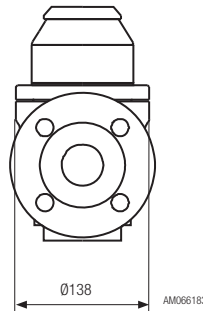

## RW, RV roller registers and dials

RW  
roller register only  
max. 180 °C

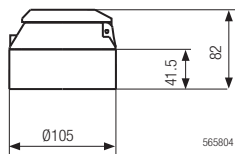

RV  
with integrated pulser (reed type)  
max. 180 °C

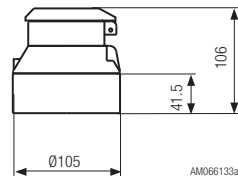

Dials  
DN 25, 40

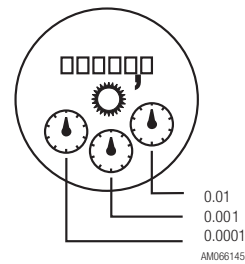

## Pulsers

### Technical data

For further technical data and wiring diagrammes, see sections "Pulsers" (page 20) and "Remote pulse transmissions" (page 22).

### Pulse values

Pulser type <sup>1)</sup>	Nominal diameter of measuring unit		
	mm	25	40
	inch	1	1 1/2
RV Reed switch	l/pulse	1	1
IN Inductive switch (NAMUR)	l/pulse	0.1	0.1
	l/pulse	1	1
INA Inductive switch (NAMUR)	approx. l/pulse	0.01032	0.03956

<sup>1)</sup> High temperature versions are designated with H.

### Pulse frequencies

IN 0.1	at Qmax	Hz	13.889	33.333
	at Qmin	Hz	0.389	1.111
INA	at Qmax	Hz	134.582	84.260
	at Qmin	Hz	3.768	2.809



### Pulser modules

IN inductive pulser according to IEC 60947-5-6 (NAMUR)

High resolution INA inductive pulser according to IEC 60947-5-6 (NAMUR)

IN  
max. 130 °C

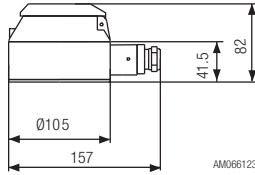

INA  
max. 90 °C

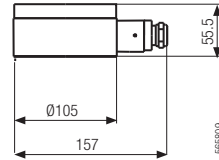

INAH  
max. 180 °C

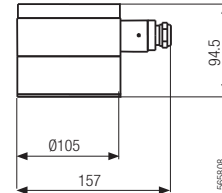

### AS / ASP mechanical batching controls

GTAS module  
for AS / ASP  
max. 180 °C

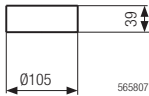

GTAS with dosing control (optional)  
with AS 110, 120  
max. 180 °C

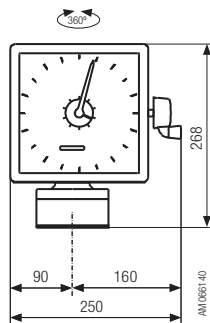

all other AS  
max. 180 °C

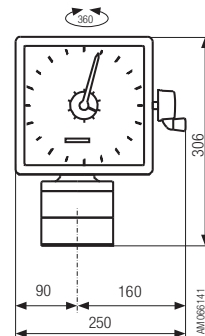

with ASP  
max. 180 °C

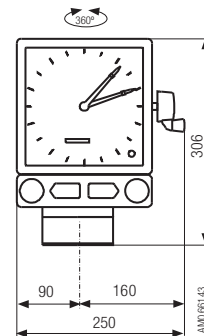

Ignition protection type "constructional safety c".

For technical data on AS / ASP batching control modules see separate Technical Documentation.

### Options for external electronic batching controls

max. 90 °C  
max. 180 °C

INA / RD.. recommended (others also possible)  
INAH / RD.. recommended (others also possible)

Wall or front panel mounting

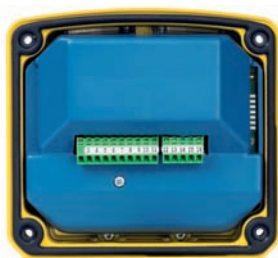

### ATEX Directive

With the exception of the - RV ... - ancillary groups, all DOMINO components are certified according to ATEX Directive 94/9/EC.

Marking: II2G cT6

The EC-Type-Examination Certificate is available on our website.

# DOMINO PMD vane wheel flowmeters

## Technical data



- Primarily used for water flow measurement or dosing
- Brass housing with threaded connections or threaded flanges
- For horizontal installation - dial upward
- Measuring tolerances  $\pm 2\%$  of effective value <sup>1)</sup>, repeatability  $\pm 0.3\%$
- Temperature max. 90 °C
- Rated pressure 16 bar
- Available only with modules "pulsar with roller register" or "installation for batching control".

Nominal diameter	DN	mm	20	25	40
		inch	3/4	1	1 1/2
Overall length		mm	190	260	300
Rated pressure PN		bar	16	16	16
Max. temperature	T <sub>max</sub>	°C	90	90	90
Maximum flow rate	Q <sub>max</sub>	l/h	5000	7000	20000
<b>Continuous flow rate</b>	<b>Q<sub>n</sub></b>	<b>l/h</b>	<b>2500</b>	<b>3500</b>	<b>10000</b>
Transitional flow rate	Q <sub>t</sub>	l/h	200	280	800
Minimal flow rate	Q <sub>min</sub>	l/h	100	140	400
With AS 110 filling control:					
Transitional flow rate	Q <sub>t</sub>	l/h	350	450	1000
Minimal flow rate	Q <sub>min</sub>	l/h	250	300	600
Smallest registered value		l	0.1	0.1	0.1
Metering capacity		m <sup>3</sup> /h	100000	100000	100000
Metering time at Q <sub>n</sub> without overflow		h	40000	28500	10000
Safety filter mesh size in meter base		mm	1.5	1.5	2.5
Housing thread		inch	1	1 1/4	2
Screw connection thread		inch	3/4	1	1 1/2
Housing finish		enamelled yellow RAL 1007			
Weight without screw connections		kg	3.10	4.10	6.50

1)  $\pm 5\%$  at lower end of measuring range between Q<sub>min</sub> and Q<sub>t</sub>.

## Measuring module materials

Component	Materials
Housing	Brass
Measuring unit	PPO plastic
Seals	EPDM (ethylene propylene)
Vane wheel bearings	Plastic and synthetic ruby balls

## Pressure drop characteristics

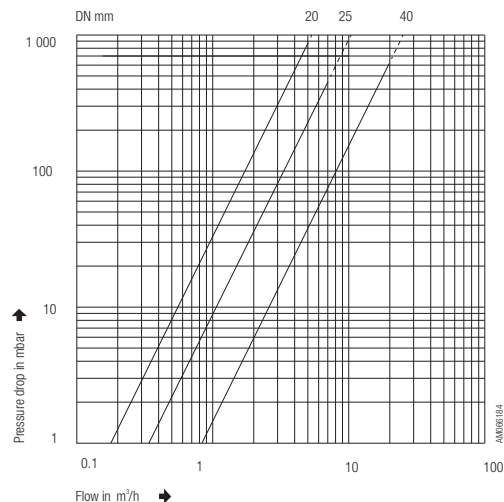

## Measuring module dimensions in mm

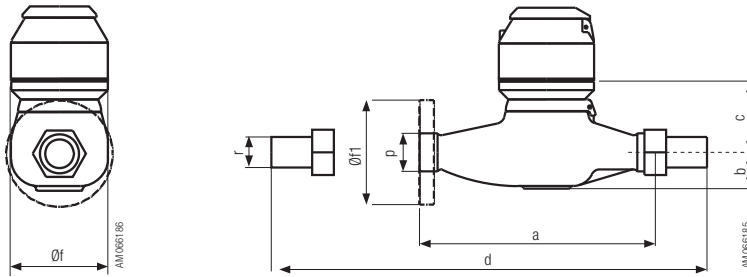

## Dials

DN 20, 25, 40

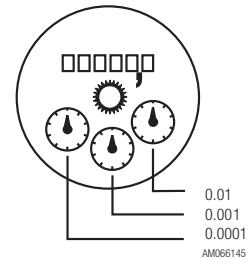

	DN	a	b	c	d	Øf	Øf1	p	r
PMD 20	20	190	37	74	285	92	105	G 1"	G 3/4"
PMD 25	25	260	40	83	375	105	115	G 1 1/4"	G 1"
PMD 40	40	300	60	91	440	139	150	G 2"	G 1 1/2"

Module installation heights are given in sections "AMD modules".

## Pulsers

### Technical data

For further technical data and wiring diagrams, see sections "Pulsers" (page 20) and "Remote pulse transmissions" (page 22).

### Pulse values

Nominal diameter of measuring unit			mm	20	25	40
Pulser type			inch	3/4	1	1 1/2
IN	Inductive switch (NAMUR)		l/pulse	0.1	0.1	0.1
			l/pulse	1	1	1
INA	Inductive switch (NAMUR)	approx.	l/pulse	0.00864	0.01434	0.04990

### Pulse frequencies

IN	at Qmax	Hz	13.889	19.444	55.555
	at Qmin	Hz	0.278	0.389	1.111
INA	at Qmax	Hz	160.751	135.596	111.334
	at Qmin	Hz	3.215	2.712	2.227

**AS/ASP mechanical batching controls:** Same specifications and dimensions as for AMD (page 17).

**For external electronic batching controls:** Same specifications and dimensions as for AMD (page 17).

## ATEX



With the exception of the - RV ... - ancillary groups, all DOMINO components are available with ATEX approval according to Directive 94/9/EC for use in hazardous locations zone 1. Classification II 2G c T6 (pulsers IN, INH, INAH: EEx ia IIC T6).

# Pulsers

## IN: Inductive pulser with decadic pulse values

### INA: High-resolution inductive pulser

Pulser types IN, INA  
for industrial applications

IN, INA pulser module

Wiring diagramme

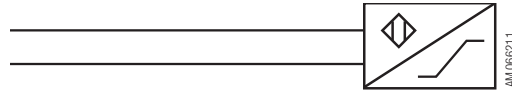

Switching element:  
Switching voltage:  
Residual ripple:  
Switching current:  
Static current:  
Switch-on time:  
Ambient temperature:  
Protection class:  
Use in explosion risk zones:  
Connections:

- Slotted disc initiator according to IEC 60947-5-6
- 5...15 V DC
- max. 5 %
- > 3 mA (at 8 V DC, 1 KOhm)
- < 1 mA (at 8 V DC, 1 KOhm)
- 50 ± 10 %
- -10 ... +70 °C
- IP 65 (IEC 60529) against water-jets and dust
- Available with ATEX Certificate II 2 G EEx ia IIC T6 for use in hazardous areas
- Connect cabel (min. 2 x 0.35 mm<sup>2</sup>) to pulser probe with plug provided. Cable outer diameter 4...6 mm. For use in explosion risk zones are preferably light blue cables to be used. See local regulations for Ex risk use!

## RV: Reed pulser with decadic pulse values

RV pulser for remote totalizing integrated in roller register

Wiring diagramme

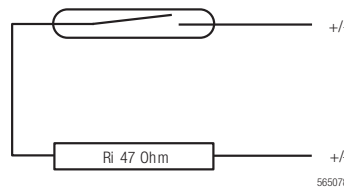

This simple version of a reed pulser is suitable for remote totalizing. For industrial control systems the IN or INA versions are recommended. Electronic pulse counters have low switching power consumption. They are therefore energized directly from the pulser. Electromechanical pulse counters with power consumption exceeding 2 W require an intermediate switching relay (e.g. WE 77).

Switching element:  
Switching voltage:  
Switching current:  
Static current:  
Switching power:  
Ambient temperature:  
Protection class:  
Connection:

- Reed contact tube filled with inert gas
- max. 48 V AC or DC
- max. 50 mA (internal resistance 47 Ohm/0.5 W)
- open contact
- max. 2 W
- -10 ... +70 °C
- IP 65 (IEC 60529) protection against water-jets and dust
- Permanent mounted grey cable, 3 m long, 2 x 0.14 mm<sup>2</sup> cross section

# System planning

## Plant design

### Layout of piping and meter installation

The piping layout must ensure that the flowmeter is always full of liquid, and that no air or gas can enter. All consumers must be connected to the meter.

All meters and modules should be easily accessible for reading. Do not install meters facing downwards. Straight piping for flow stabilization is not required.

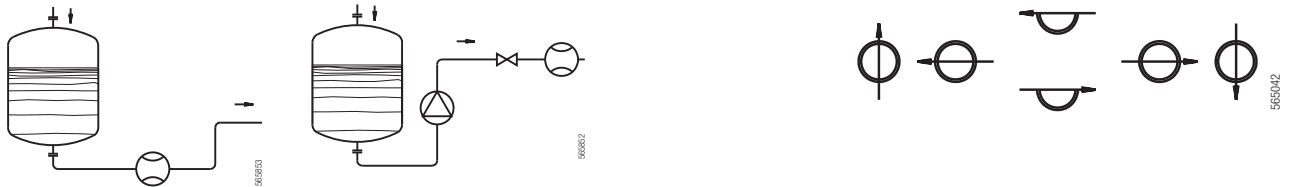

### Meters with additional modules

Install in the position shown in the module instructions.

### Meters without additional modules

ARD rotary piston meters can be installed in horizontal, vertical or other positions.

AMD and PMD vane wheel meters must always be installed horizontally.

### Selection of meters and auxiliaries

Meters and auxiliaries must be chosen to cover all plant operating conditions:

1. Operating pressure and temperature according to type plate
2. Ambient temperature -10 ... +60 °C
3. Material resistance: dependent on measuring medium and ambient conditions
4. Flow capacity

Flowmeters must be dimensioned according to flow rate rather than pipe diameter. If necessary, change the calibre.

### Shut-off valves

Shut-off valves must be installed downstream of the flowmeter in order to prevent return flow and emptying.

Return flow and emptying causes measurement errors and damages the flowmeter.

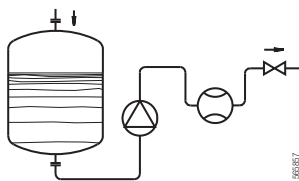

### Dirt filter, Safety filter

To prevent damage to the flowmeter, a dirt trap or prefilter should be installed upstream of the flowmeter.

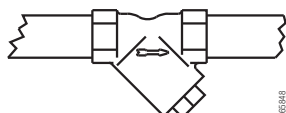

Max. prefilter mesh width:

ARD rotary piston flowmeter:

- DN 15 mm 0.1 mm
- DN 20 mm 0.1 mm
- DN 25 mm 0.25 mm
- DN 40 mm 0.25 mm
- DN 50 mm 0.25 mm

AMD and PMD vane wheel flowmeters:

Dirt traps are only necessary if the medium contains particles larger than 1-2 mm. Max. mesh width 0.8 mm. The filter in the meter intake is purely for safety reasons. It is too small to function as a dirt trap.

**Filling/batching systems**

For filling/batching systems the valve must be installed between the flowmeter and outlet. Short pipes between the flowmeter to the outlet give the greatest accuracy. To prevent water hammer, do not open or close valves too quickly. Water hammer will damage the flowmeter.

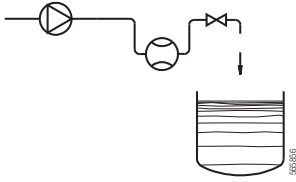

**Remote evaluation / auxiliary units**

In flowmeters with pulsers for remote display, return flow must be prevented. If the system layout does not ensure this, a non-return valve must be installed.

**Electrical cable layout**

Electrical cables and installations are subject to legal regulations which must be taken into account during system planning. All cabling must be installed by professional electricians. System layout must take account of:

- 1. Auxiliary equipment connections
- 2. Maximum cable lengths with/without amplifiers
- 3. Distributor boxes / cable ducts
- 4. Ambient interference factors

Electrical installations in explosion-risk zones are subject to special regulations. Flowmeters in such zones must adhere to particular requirements. Consult a explosion risk expert.

**Remote pulse transmission**

**Pulser power supply**

For remote evaluation of flowmeter readings, passive pulsers are available. The pulser must be powered from the connected unit. It generates one pulse per volumetric unit.



**Selection of correct pulser**

The correct pulser and best pulse value depends on the remote evaluation system. For remote totalization, large pulse values are generally selected (e.g. 10 litres / pulse). For instantaneous values, analogue signals and filling system control, small values should be selected. For battery-powered evaluation units, only reed-type pulsers can be used.

**Requirements of energizing units**

The pulse duration depends on the flow. At zero flow permanent contact may occur. The unit connected must therefore be designed for continuous loading. Otherwise protection e.g. by wiping relays must be provided.

**Correct pulse evaluation**

If flow is interrupted, fluid oscillation may occur in some systems (hydraulic vibrations at very low forward and reverse flows). In such cases pulses may be generated which are interpreted by the evaluation unit as forward flow. For instantaneous flow readings, these do not cause any interference because they can only occur when the flow is practically zero. If the pulser controls a numerical function, however, hydraulic vibrations must be prevented by suitable means.

**Pulse values and duration**

These depend on the type and nominal diameter of the flowmeter. Pulse values are indicated on the meter type plate. The pulse duration and the switch-on and switch-off times are calculated with the following formulas:

Pulse period in s =  $\frac{\text{pulse value in l} \times 3600}{\text{flow rate Q in l/h}}$

Switch-on time =  $\frac{\text{pulse period in s} \times \text{switch-on time in \%}}{100}$

Switch-off time = pulse period minus witch-on time

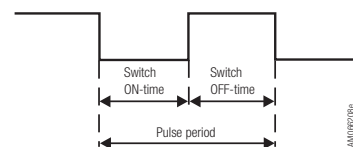

It is recommended to calculate these values for the smallest and largest flowrates expected in the system.

# Ordering information

## ARD sensors: Type designations and order numbers

(for standard versions; special versions on request)

### ARD 1000 measuring module

Measuring chamber	Seal	Rotary piston	PN bar	T <sub>max</sub> °C	Type designation	Nominal diameter				
						15	20	25	40	50
<b>Brass housing with threaded connections</b>										
Brass / PPS	FPM	Aluminium	16	130	ARD../1111-A2	83000	83033	83058	-	-
		Hard rubber	16	50	ARD../1111-H2	83001	83034	83059	-	-
		Graphite	16	130	ARD../1111-G2	83002	83035	83060	-	-
		PTFE	16	40	ARD../1111-P2	83004	83036	83062	-	-
<b>Spherulitic cast iron housing with threaded connections</b>										
Brass / PPS	FPM	Aluminium	16	130	ARD../1211-A2	-	-	-	83106	-
		Hard rubber	16	50	ARD../1211-H2	-	-	-	83107	-
		Graphite	16	130	ARD../1211-G2	-	-	-	83108	-
		PTFE	16	40	ARD../1211-P2	-	-	-	83110	-
<b>Spherulitic cast iron housing with flanged connections</b>										
Brass / PPS	FPM	Aluminium	25	130	ARD../1221-A2	83005	83037	83063	83111	83154
		Hard rubber	25	50	ARD../1221-H2	83006	83038	83064	83112	-
		Graphite	25	130	ARD../1221-G2	83007	83039	83065	83113	83155
Brass / PPS <sup>1)</sup>	FPM	Aluminium	25	130	ARD../1228-A2	83350	83351	83352	83353	83354
Brass / PTFE	FPM	Aluminium	25	180	ARD../1222-A2	83009	83040	83067	83115	83157
		Graphite	25	180	ARD../1222-G2	83010	83041	83068	83116	83158
		PTFE	25	40	ARD../1222-P2	83011	83042	83069	83117	83169
Brass / PTFE <sup>1)</sup>	FPM	Aluminium	25	180	ARD../1223-A2	83012	83043	83070	83118	83160

1) Measuring chamber, particularly for heavy fuel oil (measuring tolerance ±1 %)

### ARD 2000 measuring module

Measuring chamber	Seal	Rotary piston	PN bar	T <sub>max</sub> °C	Type designation	Nominal diameter				
						15	20	25	40	50
<b>Spherulitic cast iron housing with flanged connections</b>										
Stainless steel / PPS	FPM	Aluminium	40	130	ARD../2224-A2	83013	83218	83071	83119	83161
		Graphite	40	130	ARD../2224-G2	83014	83219	83072	83120	83162
		Stainless steel	40	130	ARD../2224-S2	83015	83220	83073	83121	83163
		PTFE	40	40	ARD../2224-P2	83017	83221	83075	83123	83165
Stainless steel / PTFE	FPM	Aluminium	40	180	ARD../2225-A2	83018	83044	83076	83124	83166
		Graphite	40	180	ARD../2225-G2	83019	83045	83077	83125	83167
		Stainless steel	40	180	ARD../2225-S2	83020	83046	83078	83126	83168
		PTFE	40	40	ARD../2225-P2	83021	83047	83079	83127	83169
Stainless steel / PTFE	PTFE	Graphite	40	180	ARD../2225-G6	83022	83048	83080	83128	83170
		Stainless steel	40	180	ARD../2225-S6	83023	83049	83081	83129	83171
		PTFE	40	40	ARD../2225-P6	83024	83050	83082	83130	83172

### ARD 3000 measuring module

Measuring chamber	Seal	Rotary piston	PN bar	T <sub>max</sub> °C	Type designation	Nominal diameter				
						15	20	25	40	50
<b>Stainless steel (corrosion and acid-proof) housing with flanged connections</b>										
Stainless steel / PTFE	FPM	Hard rubber	25	50	ARD../3315-H2	83025	83051	83095	83143	-
		Graphite	25	180	ARD../3315-G2	83026	83052	83096	83144	83173
		Stainless steel	25	180	ARD../3315-S2	83027	83053	83097	83145	83174
		PTFE	25	40	ARD../3315-P2	83028	83054	83098	83146	83175
Stainless steel / PTFE	PTFE	Graphite	25	180	ARD../3315-G6	83029	83055	83099	83147	83176
		Stainless steel	25	180	ARD../3315-S6	83030	83056	83100	83148	83177
		PTFE	25	40	ARD../3315-P6	83031	83057	83101	83149	83178

## ARD 4000 measuring module

Measuring chamber	Seal	Rotary piston	PN bar	T <sub>max</sub> °C	Type designation	Nominal diameter				
						15	20	25	40	50
<b>PTFE plastic housing with flanged connections</b>										
PTFE / Tantal	FFKM	PTFE	10	50	ARD../4467-P5	-	-	83105	83153	-

## Type designation key for device identification

### Example of type designation key

**ARD 25 / 1 22 3 / A 2 / J16**

Type series	ARD		ARD								
Nominal diameter	15 mm			15							
	20 mm			20							
	25 mm			25							
	40 mm			40							
	50 mm			50							
Configuration group	/1000				1						
	/2000				2						
	/3000				3						
	/4000				4						
Housing	Threaded	Brass				11					
		Spherulitic cast iron				21					
	Flanged	Spherulitic cast iron					22				
		Stainless steel					31				
		PTFE					46				
Measuring chamber	Brass / PPS						1				
	Brass / PTFE						2				
	Brass / PTFE (1 %) <sup>1)</sup>						3				
	Stainless steel / PPS						4				
	Stainless steel / PTFE						5				
	PTFE / Tantal						7				
	Brass / PTFE (1 %) <sup>1)</sup>						8				
Rotary piston	Aluminium							A			
	Hard rubber							H			
	Graphite							G			
	Stainless steel							S			
	PTFE							P			
Seal set	FPM Fluoroelastomer								2		
	FFKM Perfluoroelastomer								5		
	PTFE Polytetrafluoroethylene								6		
Flange drillings	DIN	PN 10 / 16 / 25 / 40									
		ANSI	150 PSI								A150
			300 PSI								A300
	600 PSI								A600		
	JIS	K5									J5
		K10									J10
K16									J16		
K30									J30		

<sup>1)</sup> Measuring chamber, particularly for heavy fuel oil measuring tolerance ± 1 %



## ARD modules: Type designations and order numbers

(for standard versions; special versions on request)

Pulser module Pulse values in litres	Roller register RV Pulse values in litres	T <sub>max</sub> °C	Type designation	Nominal diameter						
				15	20	25	40	50		
<b>RW module 180 °C</b>				180	RW/RD ..	83500	83526	83552	83578	83604
<b>IN module 130 °C</b>										
0.01		130	IN 0.01/RW/RD..	83509	83535	-	-	-		
0.1		130	IN 0.1/RW/RD..	83512	83538	83561	83587	-		
1		130	IN 1/RW/RD..	-	-	83564	83590	83613		
10		130	IN 10/RW/RD50	-	-	-	-	83616		
<b>IN module 180 °C</b>										
0.01		180	IN 0.01H/RW/RD..	83513	83539	-	-	-		
0.1		180	IN 0.1H/RW/RD..	83516	83542	83565	83591	-		
1		180	IN 1H/RW/RD..	-	-	83568	83594	83617		
10		180	IN 10H/RW/RD50	-	-	-	-	83620		
<b>INA module 90 °C</b>										
High-resolution		90	INA/RW/RD..	83517	83543	83569	83595	83621		
High-resolution	Sealing plate	90	INA/RD..	83520	83546	83572	83598	83624		
<b>INA module 180 °C</b>										
High-resolution		180	INAH/RW/RD..	83521	83547	83573	83599	83625		
High-resolution	Sealing plate	180	INAH/RD..	83524	83550	83576	83602	83628		
<b>GTAS module for AS / ASP batching controls 180 °C</b>				180	GTAS/RD..	83685	83686	83687	83688	83689

### ATEX-modifications

96044 Modifications for ATEX devices

Pulser module Pulse values in litres	Roller register RV Pulse values in litres	T <sub>max</sub> °C	Type designation	Nominal diameter					
				15	20	25	40	50	
<b>RV module 180 °C - Not available with ATEX Certificate</b>									
0.1		180	RV 0.1/RD15	83501	-	-	-	-	
1		180	RV 1/RD..	83502	83527	83553	83579	-	
10		180	RV 10/RD..	-	83528	83554	83580	83605	
100		180	RV 100/RD50	-	-	-	-	83606	

**Type designation key for device identification**

**Example of type designation key**

**IN 1H / RV 10 / RD 25**

Pulser	Pulse value in litres	T <sub>max</sub> °C			
None		180			
IN Inductive	0.01	130	IN 0.01		
	0.1	130	IN 0.1		
	1	130	IN 1		
	10	130	IN 10		
IN Inductive	0.01	180	IN 0.01H		
	0.1	180	IN 0.1H		
	1	180	IN 1H		
	10	180	IN 10H		
INA Inductive high-resolution		90	INA		
		180	INAH		
Module for AS / ASP filling control			GTAS		
Roller register				RW	
Roller register with integral pulser	0.1			RV 0.1	
	1			RV 1	
	10			RV 10	
	100			RV 100	
Sealing plate without roller register					
Nominal diameter of flowmeter	DN 15				RD 15
	DN 20				RD 20
	DN 25				RD 25
	DN 40				RD 40
	DN 50				RD 50
Display units	Litres				
	US-Gallons				USG

**AMD measuring modules**

Housing	Measuring unit bearings	PN bar	T <sub>max</sub> °C	Type designation	Nominal diameter	
					25	40
<b>AMD 3000</b>						
Stainless steel	Stainless steel / PTFE	16	90	AMD../3331	84002	84006
	Stainless steel / graphite	16	180	AMD../3332	84003	84007

**Type designation key for device identification**

**Example of type designation key**

**AMD 25 / 3 3 3 1 /A150**

Type series	AMD	AMD						
Nominal diameter	25 mm		25					
	40 mm		40					
Configuration group	/3000			3				
Housing	Stainless steel	PN 25			3			
Measuring unit	Stainless steel					3		
Bearings	PTFE	90 °C					1	
	Graphite	180 °C					2	
Flange drillings	DIN	PN 16 / 25						
	ANSI	150 PSI						A150
		300 PSI						A300
		600 PSI						A600
	JIS	K10						J10
	K16						J16	
	K30						J30	

## AMD modules: Type designations and order numbers

(for standard versions)

Pulser module Pulse values in litres	Roller register RV Pulse values in litres	T <sub>max</sub> °C	Type designation	Nominal diameter	
				25	40
<b>RW module</b>					
		180	RW/MD ..	84010	84016
<b>RV module</b>					
		180	RV 1/MD ..	84040	84041
<b>IN module</b>					
0.1		130	IN 0.1/RW/MD..	84012	84018
1		130	IN 1/RW/MD..	84013	84019
0.1		180	IN 0.1H/RW/MD..	on request	on request
1		180	IN 1H/RW/MD..	on request	on request
<b>INA module</b>					
High-resolution	Sealing plate	90	INA/MD..	84015	84021
High-resolution		180	INAH/MD..	on request	on request
<b>GTAS module for AS / ASP filling controls</b>					
		180	GTAS/MD	84014	84020

### ATEX-modifications

96044 Modifications for ATEX devices

### Type designation key for device identification

#### Example of type designation key

**IN 1      / RW      / MD 25**

Pulser	Pulse value in litres	T <sub>max</sub> °C			
None					
IN Inductive	0.1	130	IN 0.1		
	1	130	IN 1		
INA Inductive high-resolution		90	INA		
		180	INAH		
Module for AS / ASP filling control			GTAS		
Roller register		180		RW	
Roller register with integral pulser	1			RV 1	
Nominal diameter of flowmeter	DN 25				MD 25
	DN 40				MD 40
Display units	Litres				

## Complete PMD flowmeters

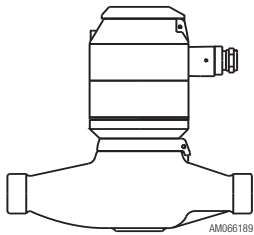
	Type designation	Version	Order No.
	PMD 20 - IN 0.1	with inductive pulser IN 0.1 l	84023
	PMD 20 - IN 1	with inductive pulser IN 1 l	84024
	PMD 20 - INA	with high-resolution pulser	on request
	PMD 20 + adapter	prepared for batching control system	84025
	PMD 25 - IN 0.1	with inductive pulser IN 0.1 l	84027
	PMD 25 - IN 1	with inductive pulser IN 1 l	84028
	PMD 25 - INA	with high-resolution pulser	on request
	PMD 25 + adapter	prepared for batching control system	84029
	PMD 32 - IN 0.1	with inductive pulser IN 0.1 l	84035
	PMD 32 - IN 1	with inductive pulser IN 1 l	84036
	PMD 32 - INA	with high-resolution pulser	on request
	PMD 32 + adapter	prepared for batching control system	84037

PMD: for versions without pulser or with reed-pulser type RH use type PMK (up to 40 °C) or PMW (up to 90 °C).

## ATEX-modifications

96044 Modifications for ATEX devices

## Accessories

Type designation	Version	Order No.
Remote totalizer	Pulse counter, count step, with or without zeroing, adjustable	93374
Totalizer / Flowrate indicator	F113	92439
	F116 (with differential and sum function)	92440
Threaded connections	VSR 1/2" for DN 15	81160
	VSR 3/4" x 1/2" for DN 20	81163
	VSR 3/4" for DN 20	81166
	VSR 1" for DN 25	81169
	VSR 1 1/2" for DN 40	81181
Batching controls	AS manual controls	on request
	ASP pneumatic controls	on request
Batching controls	F131 electronical	92441
	F131 Exi (ATEX)	92442

## Accreditations

### ATEX Directive

With the exception of the - RV ... - ancillary groups, all DOMINO components are certified according to ATEX Directive 94/9/EC.

Marking:  II2G cT6

The EC-Type-Examination Certificate is available on our website.

### Pressure Equipment Directive PED

In accordance with guideline 97/23/EC, a CE or supplier conformity declaration are available on our website for all DOMINO devices.

**ISTEC**  
Flow Measurement & Control

DISTRIBUTOR:

ISTEC CORPORATION  
5 Park Lake Road, Sparta, NJ 07871  
973 383 9888 (Phone)  
973 383 9088 (Fax)  
Email: [sales@istec-corp.com](mailto:sales@istec-corp.com)  
Web: [www.istec-corp.com](http://www.istec-corp.com)

HEAD OFFICE:

AQUAMETRO AG  
Ringstrasse 75  
CH-4106 Therwil  
Phone +41 61 725 11 22  
Fax +41 61 725 15 95  
[info@aquametro.com](mailto:info@aquametro.com)



[www.aquametro.com](http://www.aquametro.com)

Contact, Address and Stamp

Web: [www.istec-corp.com](http://www.istec-corp.com) | [sales@istec-corp.com](http://www.sales@istec-corp.com) | Phone: 877.566.3837 | Fax: 925.407.2903