



VRG
CONTROLS

VPC Valve Pilot Controllers

ver 030320

VPC Valve Pilot Controllers

Rugged and Intelligent Valve Control with Zero Steady State Emissions for Natural Gas Control Valves

VPC Valve Pilot Controllers provide a modular plug & play pressure control system for use in conjunction with pneumatically actuated control valves for natural gas pipelines. The VPC features a simple 5-in-1 configuration system that provides compatibility with double acting piston and spring return valve actuators in a single platform. The VPC may be configured to provide compatibility with almost any pneumatic control valve on the market.

- **ZERO Steady State Emissions Capable**
- **Complete Elimination of atmospheric emissions possible when “discharge to pressure system”**
- **Modular format provides flexibility and reduced tubing connections**
- **Military grade alloy provides superior corrosion resistance**
- **Only Two (2) Repair Kits cover entire product range**
- **Compatible with Other Manufacturer’s Pneumatic Control Valves**

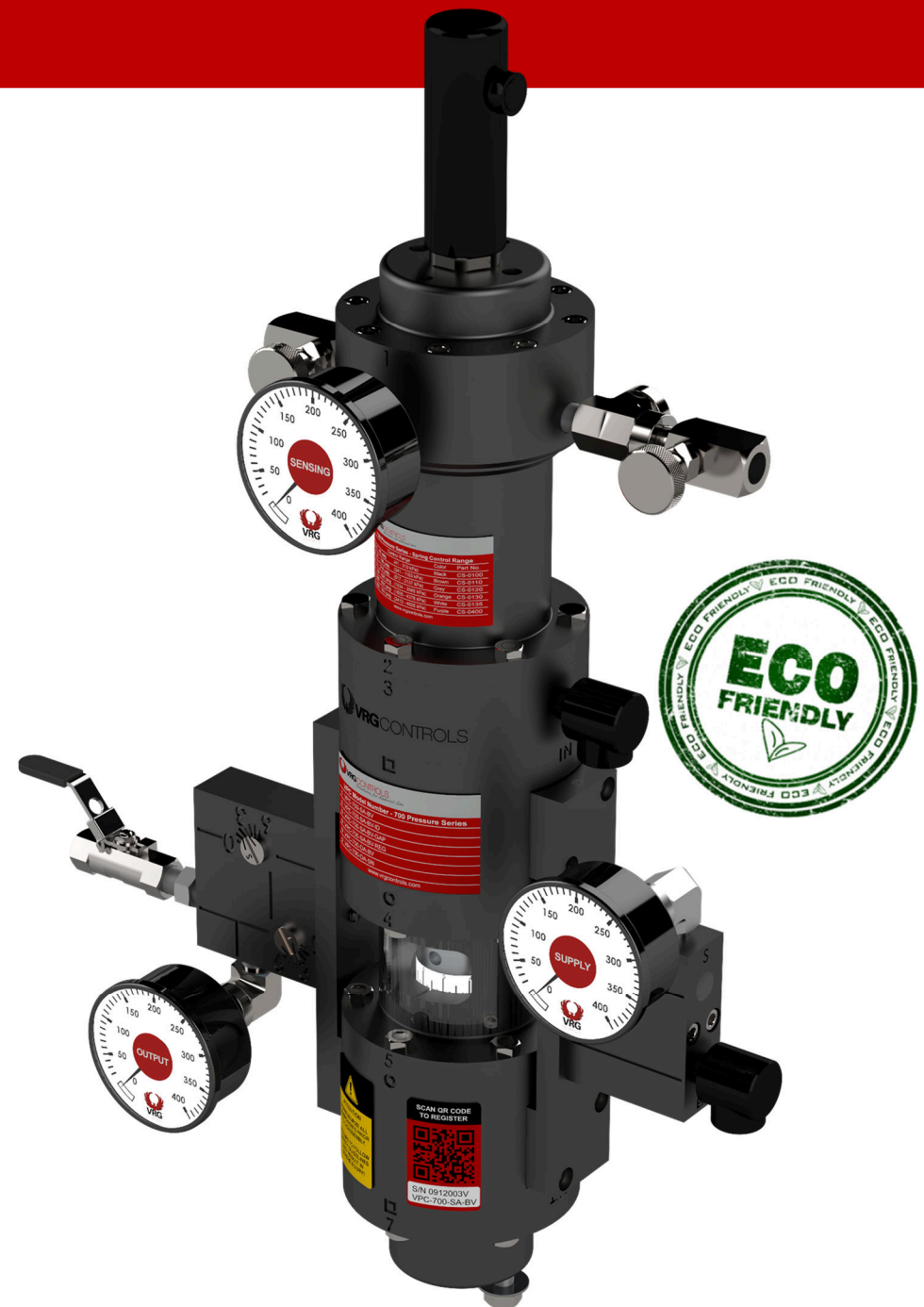

VPC Valve Pilot Controller

Features and Functions Designed For the Natural Gas Industry

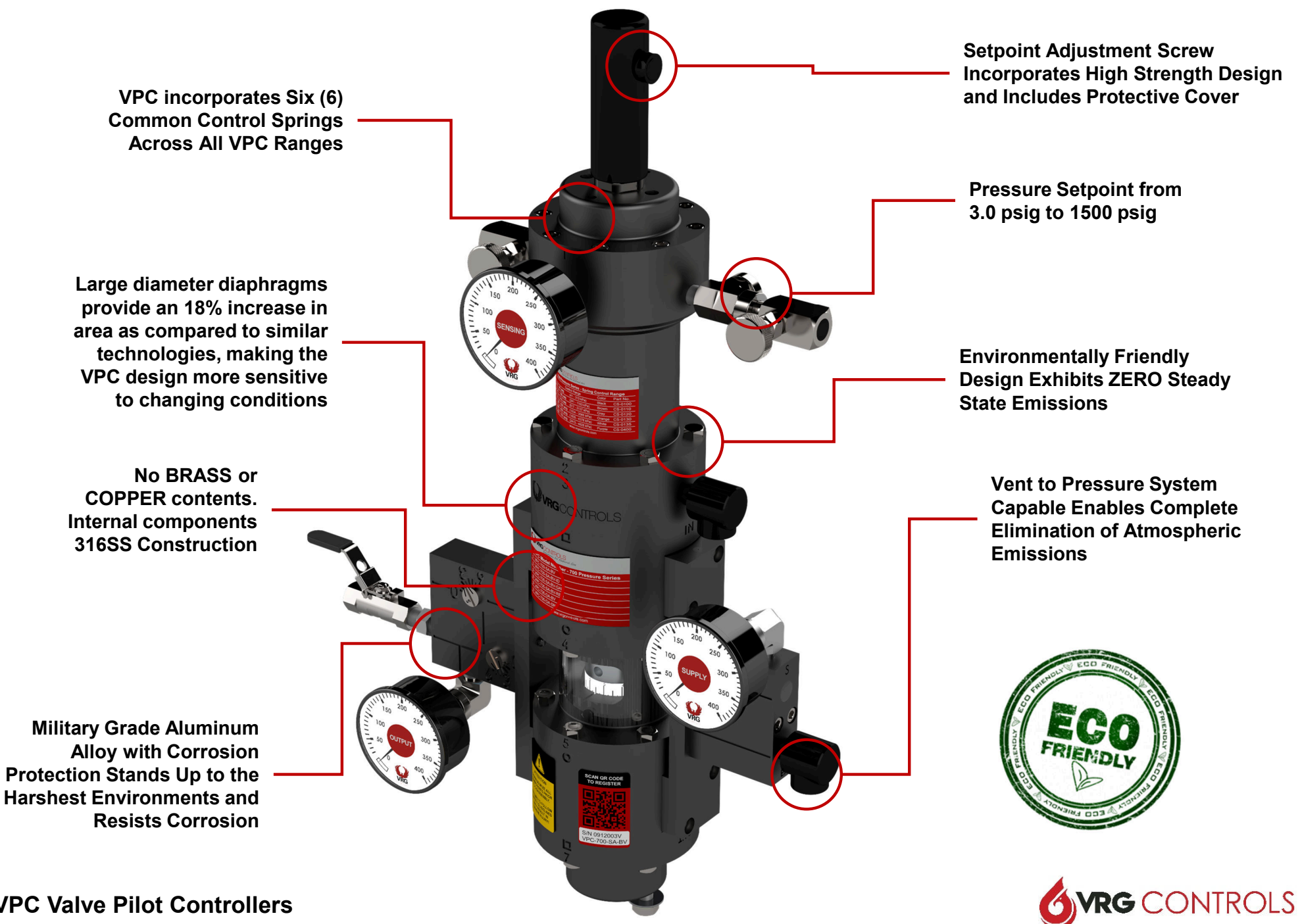

VPC incorporates Six (6) Common Control Springs Across All VPC Ranges

Setpoint Adjustment Screw Incorporates High Strength Design and Includes Protective Cover

Pressure Setpoint from 3.0 psig to 1500 psig

Large diameter diaphragms provide an 18% increase in area as compared to similar technologies, making the VPC design more sensitive to changing conditions

Environmentally Friendly Design Exhibits ZERO Steady State Emissions

No BRASS or COPPER contents. Internal components 316SS Construction

Vent to Pressure System Capable Enables Complete Elimination of Atmospheric Emissions

Military Grade Aluminum Alloy with Corrosion Protection Stands Up to the Harshest Environments and Resists Corrosion



VPC Valve Pilot Controllers



Features and Functions Designed For the Natural Gas Industry

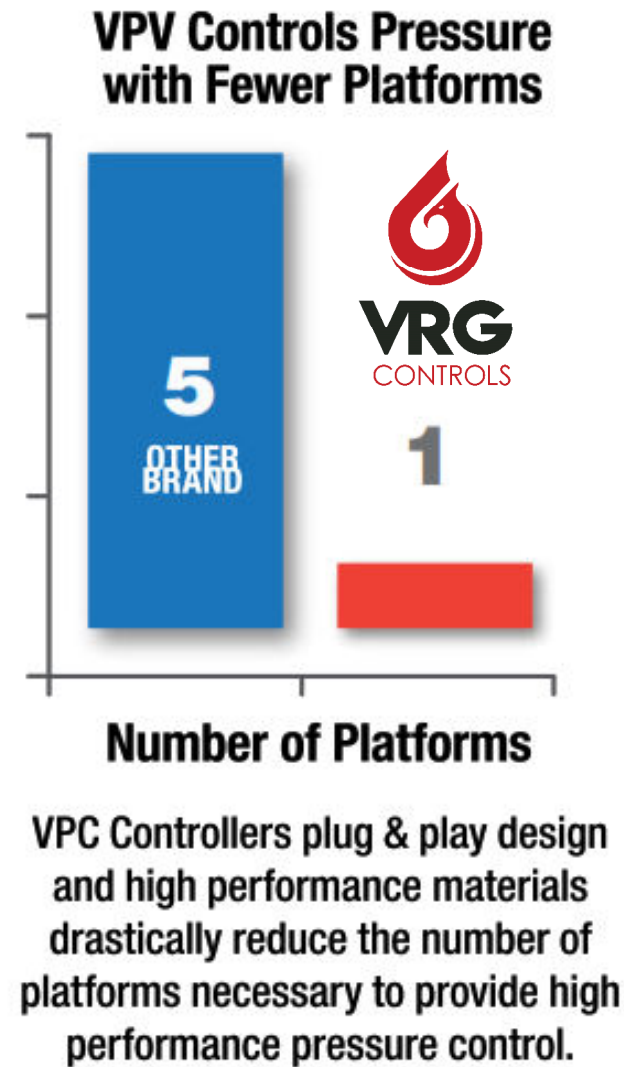
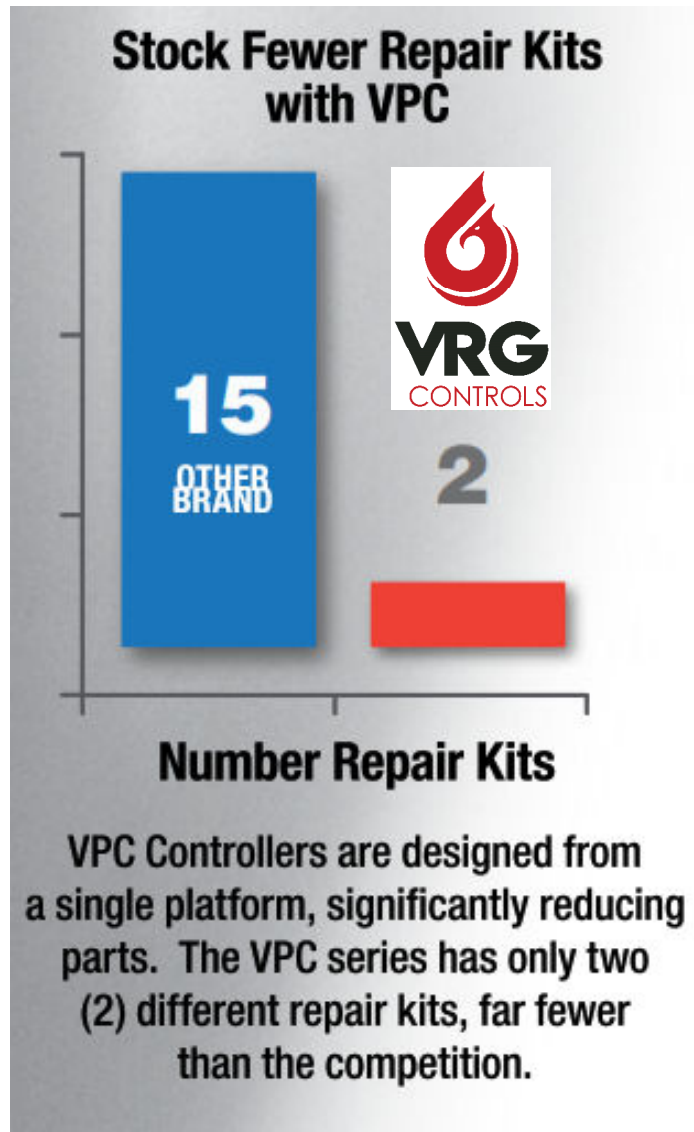

5 Plug & Play VPC Models From a Single Platform

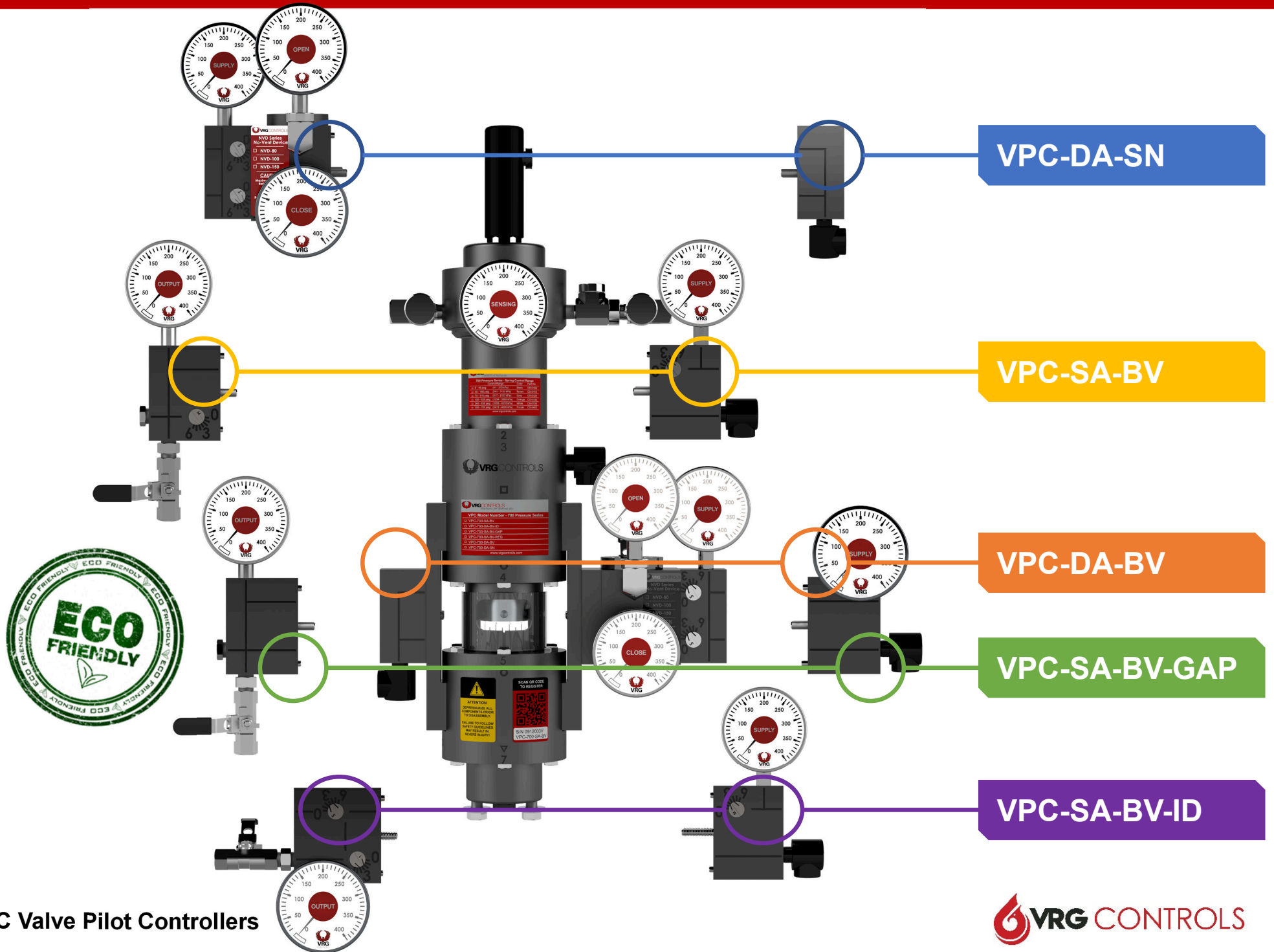

VPC Valve Pilot Controllers



VPC Valve Pilot Controllers – Emissions & Configuration

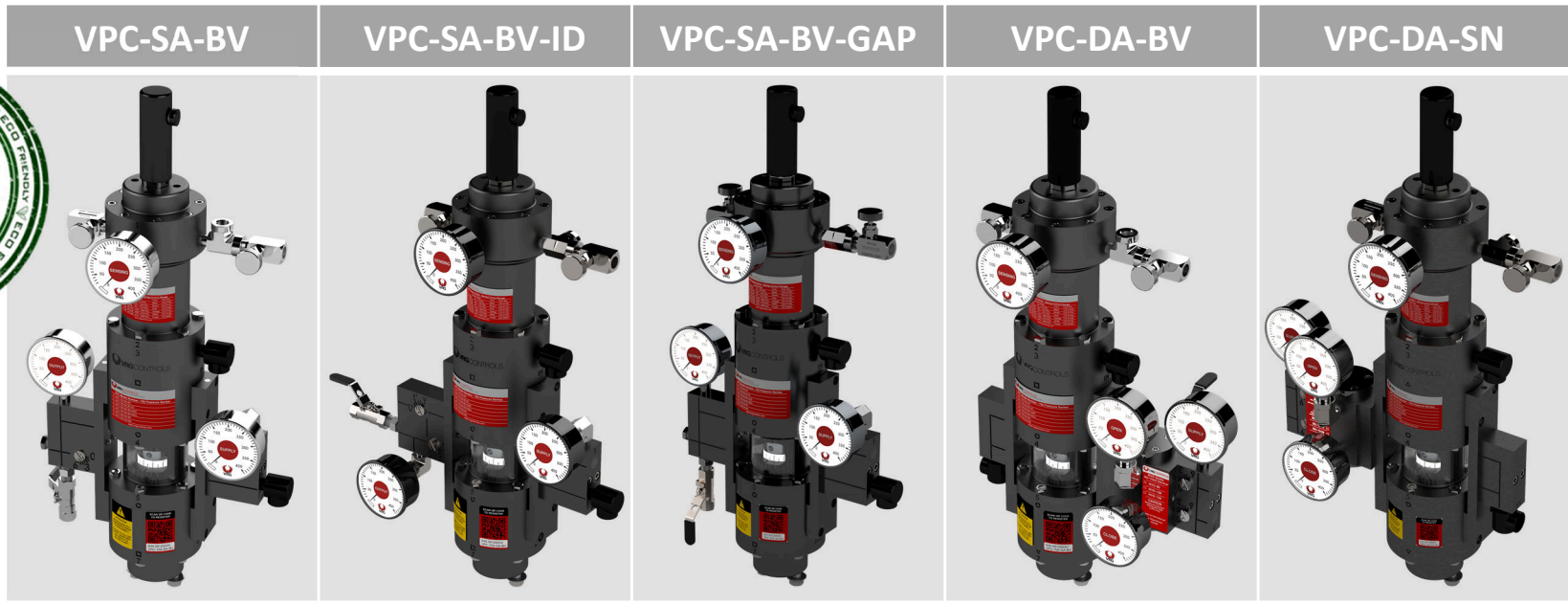

	VPC-SA-BV	VPC-SA-BV-ID	VPC-SA-BV-GAP	VPC-DA-BV	VPC-DA-SN
Type	Variable	Variable	Discrete (On-Off)	Variable	Variable
Outputs	Single Acting	Single Acting	Single Acting	Double Acting	Double Acting
Logic	NC Balanced Valve	NC Balanced Valve	NC Balanced Valve	NC Balanced Valve	NO Seat & Nozzle
Accuracy	± 0.5% Top End Control Spring Range – Instantaneous Accuracy				
Emissions					
Steady State	ZERO	ZERO	ZERO	<10 scfh	~20 scfh
Full Open Valve	ZERO	ZERO	ZERO	ZERO	ZERO
Full Closed Valve	ZERO	ZERO	ZERO	ZERO	ZERO

VPC Valve Pilot Controllers – Emissions & Configuration

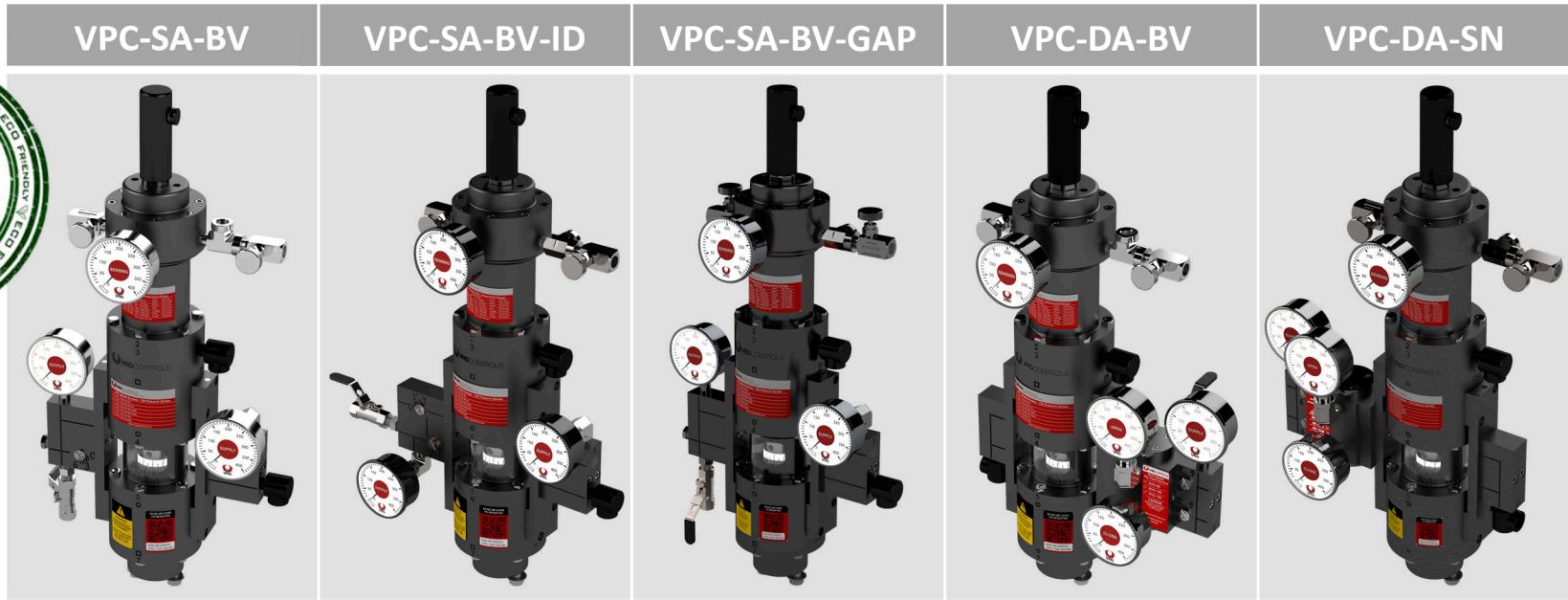

	VPC-SA-BV	VPC-SA-BV-ID	VPC-SA-BV-GAP	VPC-DA-BV	VPC-DA-SN
LD, RD Actuators	■	■	■		
RHPA-SR Actuators	■	■	■		
RHPA-DA Actuators			■	■	■
VGP Positioner		■			
Pneumatic Positioner		■			
Volume Booster		■			■
ESC Electronic	■	■	■	■	■

NOTES:

1. NC Balanced Valves and NO Seat & Nozzle internal components may be exchange/converted to meet application requirements
2. ZERO Steady State emissions achieved when VPC properly adjusted to exhibit factory advised deadband setting
3. Consumption is approximate and based upon 100 psig Supply Gas. Atmosphere emissions may be completely eliminated when Discharge to Pressure System incorporated.
4. Double acting VPC's require addition of No-Vent Device to achieve ZERO emissions at full open and full closed
5. Double Acting Piston Actuators Equipped with Single Acting VPC requires additional interface instrumentation such as pneumatic positioner or pilot-operated trigger valve (GAP)

VPC Controller Spring Ranges and Specifications – VPC-225 Series

VPC SERIES	CONTROL RANGE	SPRING COLOR	SETPOINT CHANGE PER TURN	SETPOINT ACCURACY ¹	MAX GAP SETPOINT RANGE ²	CONTROL SPRING PART NUMBER
VPC-225 SERIES	3.0-15 psig (21 - 103 kPa)	Black	0.8 psig (5.5 kPa)	±0.1 psig (±0.7 kPa)	0.1 – 0.6 psig (0.7 – 4 kPa)	CS-0100
	5 - 53 psig (55 - 365 kPa)	Brown	3.1 psig (21.4 kPa)	±0.1 psig (±0.7 kPa)	0.2 – 2.3 psig (1.4 – 15.9 kPa)	CS-0110
	16 - 100 psig (110 - 689 kPa)	Grey	8 psig (55 kPa)	±0.2 psig (1.0 kPa)	0.5 - 6 psig (3.4 - 41 kPa)	CS-0120
	40 - 170 psig (276 - 1172 kPa)	Orange	20.2 psig (139 kPa)	±0.4 psig (±2.6 kPa)	1 – 15 psig (6.9 - 103 kPa)	CS-0130
	65 - 205 psig (448 - 1413 kPa)	White	32.2 psig (222 kPa)	±0.6 psig (±4.2 kPa)	2 - 24 psig (14 - 165 kPa)	CS-0135
	100 - 225 psig (689 - 1551 kPa)	Purple	44.2 psig (305 kPa)	±0.8 psig (±5.6 kPa)	3 - 34 psig (21 - 234 kPa)	CS-0140

NOTES:

1. Setpoint Accuracy based upon proper maintenance of VPC Controller and adjustment to specification following VPC Controller Technical Manual. Standard VPC Setpoint Accuracy is reported in this table. Setpoint Accuracy may be multiplied by 0.5X (improved) by incorporating a valve positioner or volume booster.
2. Maximum "GAP" Setpoint Range applicable only to VPC-GAP Controller Configurations. The "GAP" relates to bracketed high-low trigger points for discrete on-off control logic.
3. Control Spring and VPC Series Combination not recommended for GAP control applications.

VPC Controller Spring Ranges and Specifications – VPC-700 Series

VPC SERIES	CONTROL RANGE	SPRING COLOR	SETPOINT CHANGE PER TURN	SETPOINT ACCURACY ¹	MAX GAP SETPOINT RANGE ²	CONTROL SPRING PART NUMBER
VPC-700 SERIES	9 - 45 psig (62 - 310 kPa)	Black	2.4 psig (17 kPa)	±0.5 psig (±3.4 kPa)	0.5 – 1.9 psig (3.4 – 14 kPa)	CS-0100
	30 - 160 psig (241 - 1103 kPa)	Brown	9.6 psig (73 kPa)	±0.7 psig (±4.5 kPa)	1.5 - 8 psig (10 - 55 kPa)	CS-0110
	75 - 310 psig (517 - 2137 kPa)	Grey	24.5 psig (175 kPa)	±1.6 psig (±10 kPa)	3 - 20 psig (21 - 137 kPa)	CS-0120
	150 - 520 psig (1034 - 3585 kPa)	Orange	62.1 psig (423 kPa)	±3.8 psig (±26 kPa)	5 - 49 psig (35 - 337 kPa)	CS-0130
	240 - 635 psig (1655 - 4378 kPa)	White	98.9 psig (687 kPa)	±6.2 psig (±43 kPa)	6 - 80 psig (41 - 552 kPa)	CS-0135
	350 - 700 psig (2413 - 4826 kPa)	Purple	135.9 psig (926 kPa)	±8.3 psig (±57 kPa)	8 - 107 psig (69 - 276 kPa)	CS-0140

NOTES:

1. Setpoint Accuracy based upon proper maintenance of VPC Controller and adjustment to specification following VPC Controller Technical Manual. Standard VPC Setpoint Accuracy is reported in this table. Setpoint Accuracy may be multiplied by 0.5X (improved) by incorporating a valve positioner or volume booster.
2. Maximum "GAP" Setpoint Range applicable only to VPC-GAP Controller Configurations. The "GAP" relates to bracketed high-low trigger points for discrete on-off control logic.
3. Control Spring and VPC Series Combination not recommended for GAP control applications.

VPC Controller Spring Ranges and Specifications – VPC-1500 Series

VPC SERIES	CONTROL RANGE	SPRING COLOR	SETPOINT CHANGE PER TURN	SETPOINT ACCURACY ¹	MAX GAP SETPOINT RANGE ²	CONTROL SPRING PART NUMBER
VPC-1500 SERIES	30 - 90 psig (207 - 620 kPa)	Black	5.0 psig (34 kPa)	±5.0 psig (±34 kPa)	N/A ³	CS-0100
	50 - 335 psig (345 - 2309 kPa)	Brown	19.7 psig (149 kPa)	±5.0 psig (±34 kPa)	N/A ³	CS-0110
	100 - 640 psig (689 - 4412 kPa)	Grey	50.4 psig (361 kPa)	±5.0 psig (±34 kPa)	10 - 40 psig (69 - 276 kPa)	CS-0120
	265 - 1070 psig (1827 - 7377 kPa)	Orange	127.6 psig (870 kPa)	±7.8 psig (±54 kPa)	10 - 100 psig (69 - 690 kPa)	CS-0130
	400 - 1300 psig (2758 - 8962 kPa)	White	203.2 psig (870 kPa)	±13 psig (±88 kPa)	15 - 163 psig (103 - 1125 kPa)	CS-0135
	625 - 1500 psig (4309 - 10341 kPa)	Purple	279.3 psig (1904 kPa)	±17 psig (±118 kPa)	20 - 220 psig (138 - 1522 kPa)	CS-0140

NOTES:

1. Setpoint Accuracy based upon proper maintenance of VPC Controller and adjustment to specification following VPC Controller Technical Manual. Standard VPC Setpoint Accuracy is reported in this table. Setpoint Accuracy may be multiplied by 0.5X (improved) by incorporating a valve positioner or volume booster.
2. Maximum "GAP" Setpoint Range applicable only to VPC-GAP Controller Configurations. The "GAP" relates to bracketed high-low trigger points for discrete on-off control logic.
3. Control Spring and VPC Series Combination not recommended for GAP control applications.

ESC-CMR Electronic Setpoint Controller

- Remote Setpoint Via 4-20 mA Command Signal
- If Power or Signal Lost, System Maintains Control of Process via VPC
- Electro-pneumatic Positioners Lose Control when Command Fails

High Visibility LED Readout shows Percent of Setpoint Range

Manual Override Allows Setpoint Change When Power is Not Available

Local Auto/Manual Feature

Class 1, Div. 1 Explosion Proof Design Suited for Natural Gas Applications

VPC Maintains Last Setpoint in Event of 4-20 mA Command Loss or 24 VDC Power Loss

Secure Interface Mechanism w Declutch able Drive

High Visibility LED Readout shows Percent of Setpoint Range

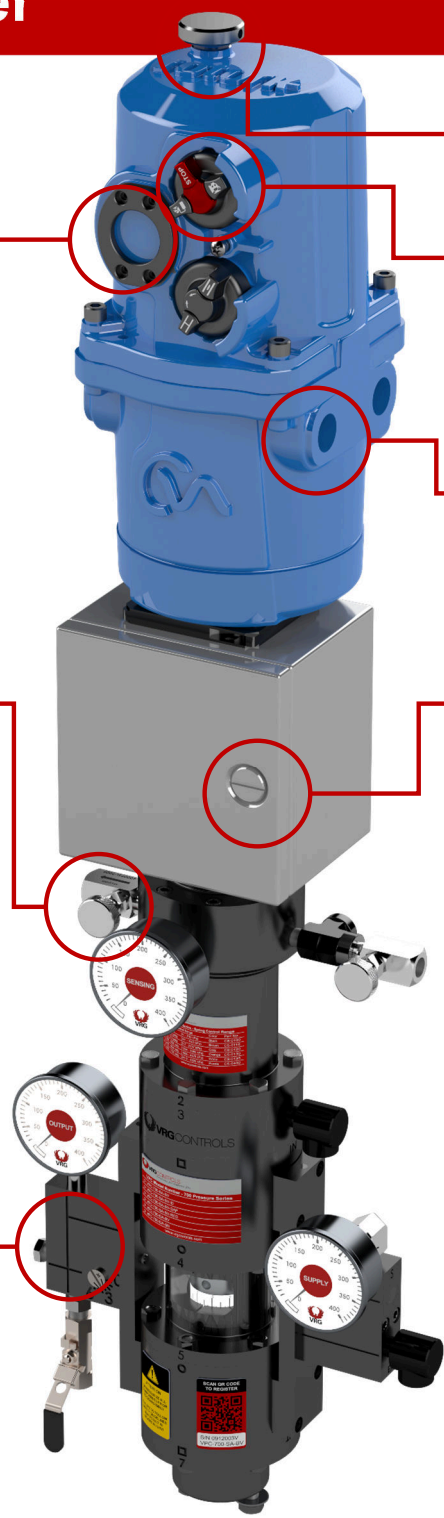

True Setpoint Readout Module – TSR6800



CMR Motor Position Feedback
(Shows Percent Motor Travel)

RTU Analog Input Card
24 VDC

True Setpoint Readout Module
(Shows Setpoint – PSIG or Other)
Scale to Custom Range



VPC Controller – Accessories & Options

SUB Submersible Option



DESCRIPTION

VRG Control Instrumentation may be equipped with SUB Submersible Option to allow for installation in vaults and other installations that frequently fill with water. The Submersible option ensures continual operation of control devices even when submerged.

FEATURES

- Applicable for AL VRG Models for VPC Valve Pilot Controllers
- Sealing System encapsulates VPC adjustment drum to prevent water intrusion
- Vent Elbow ports are configured with sealed fittings to prevent water intrusion

MODELS

Compatible with All VRG VPC Valve Pilot Controllers

NVD No Vent Device



Double Acting VPC Valve Pilot Controllers and VGP Valve Gas Positioners continue to discharge gas when the control valves is at full open and or full closed positioner. The NVD No Vent Device shuts off VPC and VGP discharge when control valves are in full open and full closed positions.

- Eliminate discharge gas at full open and full closed valve positions.
- Automatic activation and rest
- Greater sensitivity than competitor's products
- Manifold easily installed
- No adjustment necessary

NVD-150 (135 psig ≤ PSUPPLY < 150 psig)

NVD-100 (100 psig ≤ PSUPPLY < 125 psig)

NVD-80 (80 psig ≤ PSUPPLY < 100 psig)

VPC Bracket Mounting Systems

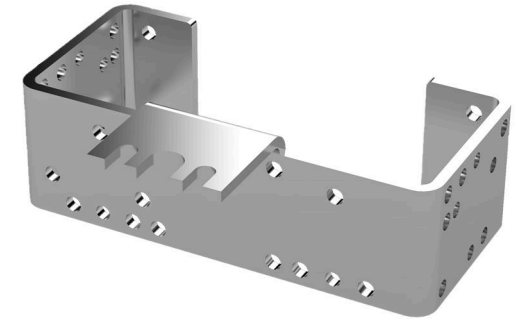

VPC Valve Pilot Controllers maybe paired with a VPC Bracket Mounting System for Convenient installation on new and retrofit applications. THE VPC Bracket includes all stainless steel hardware for 2.0 in pipe mount or flat surface installation. Additional brackets can adapt to other manufacture's actuators.

- Rugged stainless steel construction w stainless hardware
- May be installed on 2.0 in pipe mount or flat surface
- Compatible with Becker VRP Valve Pilot Controllers

Custom solutions available specific to your application.

VPC Controller – Accessories & Options

90/91 Pneumatic Selector Relay



DESCRIPTION

90 / 91 Pressure Selector Relay is designed to select the lower/higher of two signal pressure to provide an override / underide logic when two control devices are deployed together. Pressure relays are ideal companion to VPC Valve Pilot Controllers to provide override function.

FEATURES

- Compact, lightweight design
- No adjustment necessary
- Commonly used for Pressure Control Override
- Bump-less transition between pneumatic signal selection

MODELS

Model 90 – Low Select Relay
Model 91 – high Select Relay

VB Volume Booster

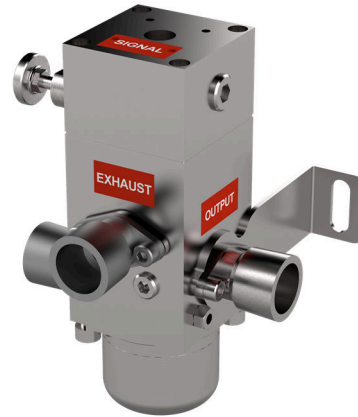

VB Volume Boosters provide high capacity output when parried with VPC Valve Pilot Controllers and BVGP Valve Gas Positioners. Volume Boosters may be utilized in conjunction with double acting and single acting devices to provide accelerated speed and greeter sensitivity.

- Max Supply Pressure 150 psig
- Compatible with VRG VPC's and VGP's
- NPT Tapped Exhaust port Standard
- Adjustable Bypass equipped for tuning
- 1:1 Pressure Loading / Output Ratio
- 316 Stainless Steel Construction
- Uniquely Capable of accepting backpressure

CP1500 Calibration Pump



CP-1500 Calibration Pump provides ability to raise/lower trapped sensing pressure to facilitate calibration of pneumatic instruments. The CP-1500 does not require any outside power source and works by compressing trapped pressure. The fine adjustment capability ensures precise pressure loading of the control device for calibration and testing purposes.

- Maximum Pressure 1500 psig
- 0.250 FNPT Port allows technicians to build customer test rigs
- Compatible with all VRG control instrumentation
- Multiple units may be combined for greater compression volume
- No outside pressure source required

Compatible with All VRG VPC Valve Pilot Controllers

VPC Controller – Accessories & Options

QE Quick Exhaust Valve



The QE Quick Exhaust Valve is a 3/2 valve that provides rapid response to unload spring return actuators when rapid response is required in direction of unloading the actuator spring. The 316SS QE is ideal for large bore monitor control valves with Spring to Close (STC) actuators to ensure rapid response.

- Provides Rapid Response of Monitor Control Valves
- Use VPC-SA-BV and Spring Return Actuators
- Simple & Cost Effective
- Easily Retrofit to Existing Installations
- 316SS Construction

0.250 NPT Ports
0.500 NPT Ports
0.750 NPT Ports and Larger

SGS Supply Gas Systems



SGS Supply Gas Systems provide a convenient pre-packaged solution for instrument supply gas. The SGS System is a cost-effective solution guaranteed to work “out of the box.” SGS Systems may be configured with a variety of components to suit your application.

- Available with Electric or Catalytic Heaters
- May be surface mounted or installed onboard a control valve assembly
- Available in pedestal mount configuration
- Available in secure stainless steel enclosures
- Pre-packaged design custom to your application

ESC Electronic Setpoint Control



THE ESC Electronic Setpoint Control provides ability to raise/lower/adjust pressure setpoint via a 4-20 mA analog or ± 24 VDC discrete signal. The ESC positions the VPC setpoint screw via a sophisticated motor interface. The ESC is typically set to lock in place “to continue to provide closed loop pressure control at most recent pressure setpoint.”

- 4-20 mA analog or ± 24 VDC discrete Input
- Compact mounting interface
- Can lock last setpoint on loss power or signal to maintain control
- Cl 1 Div 1 Ex Proof for Natural Gas Applications
- Compatible w VPC's, Becker VRP's, and Mooney Series 20/20L/20S Pilots

Compatible with All VRG VPC Valve Pilot Controllers

DESCRIPTION

FEATURES

MODELS

VPC Schematic #1 – VPC-DA-BV + NVD + ATM Ex – RHPA-DA

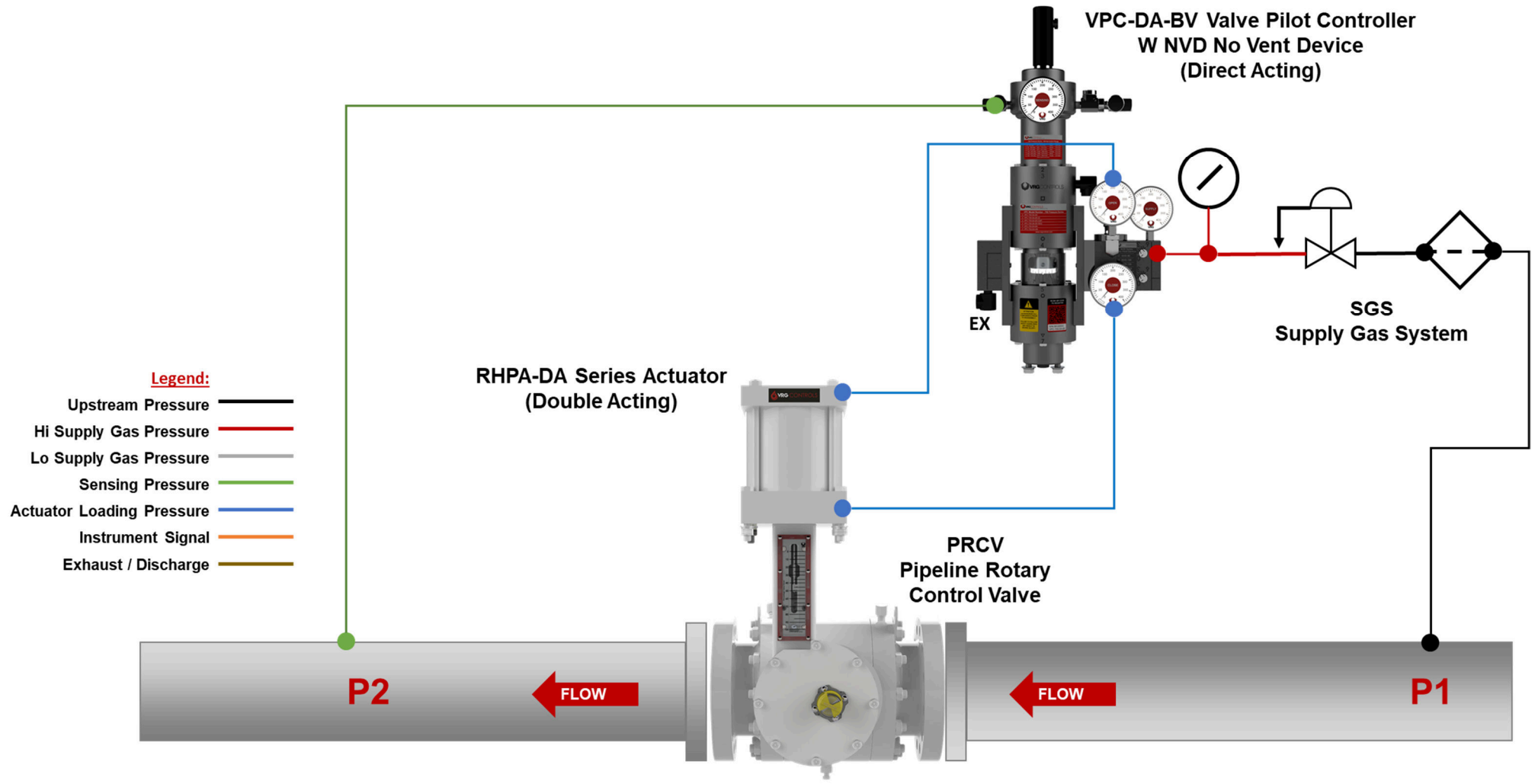

VPC Schematic #2 – VPC-DA-SN + NVD + Discharge Pressure + RHPA-DA

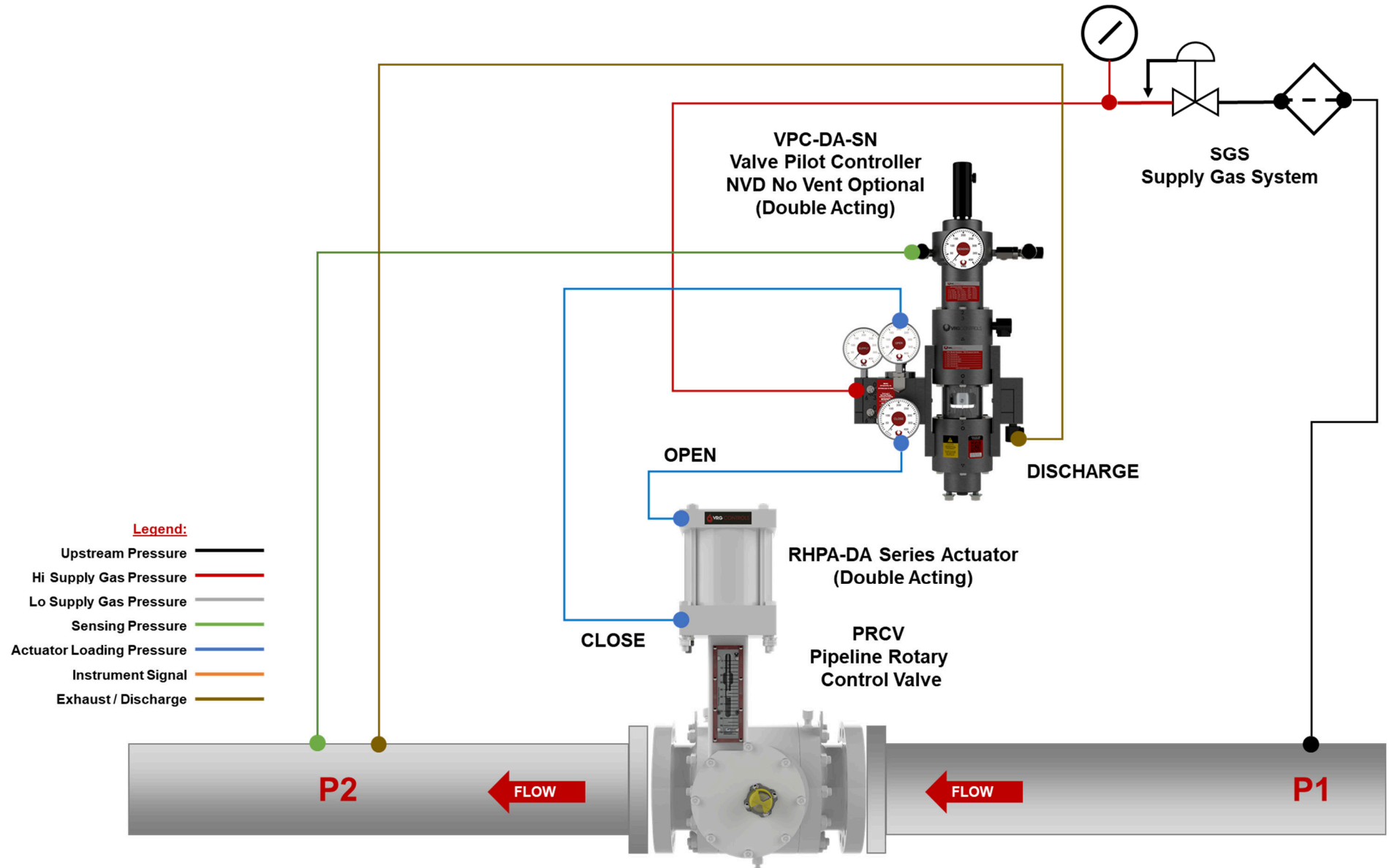

VPC Schematic #3 – VPC-SA-BV + ATM Ex + LD Actuator

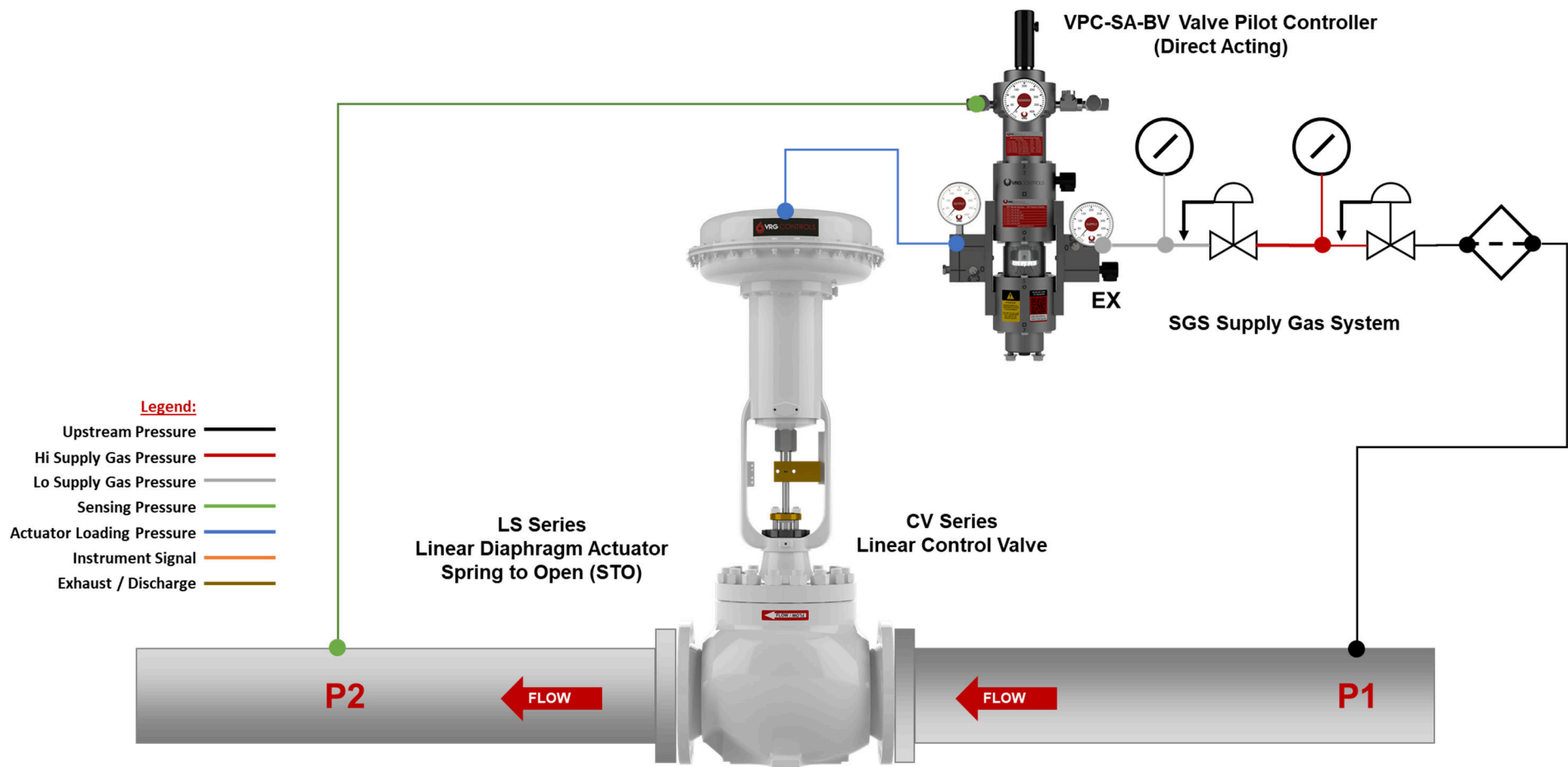

VPC Schematic #4 – VPC-SA-BV + ATM Ex + LD Actuator + Remote Set

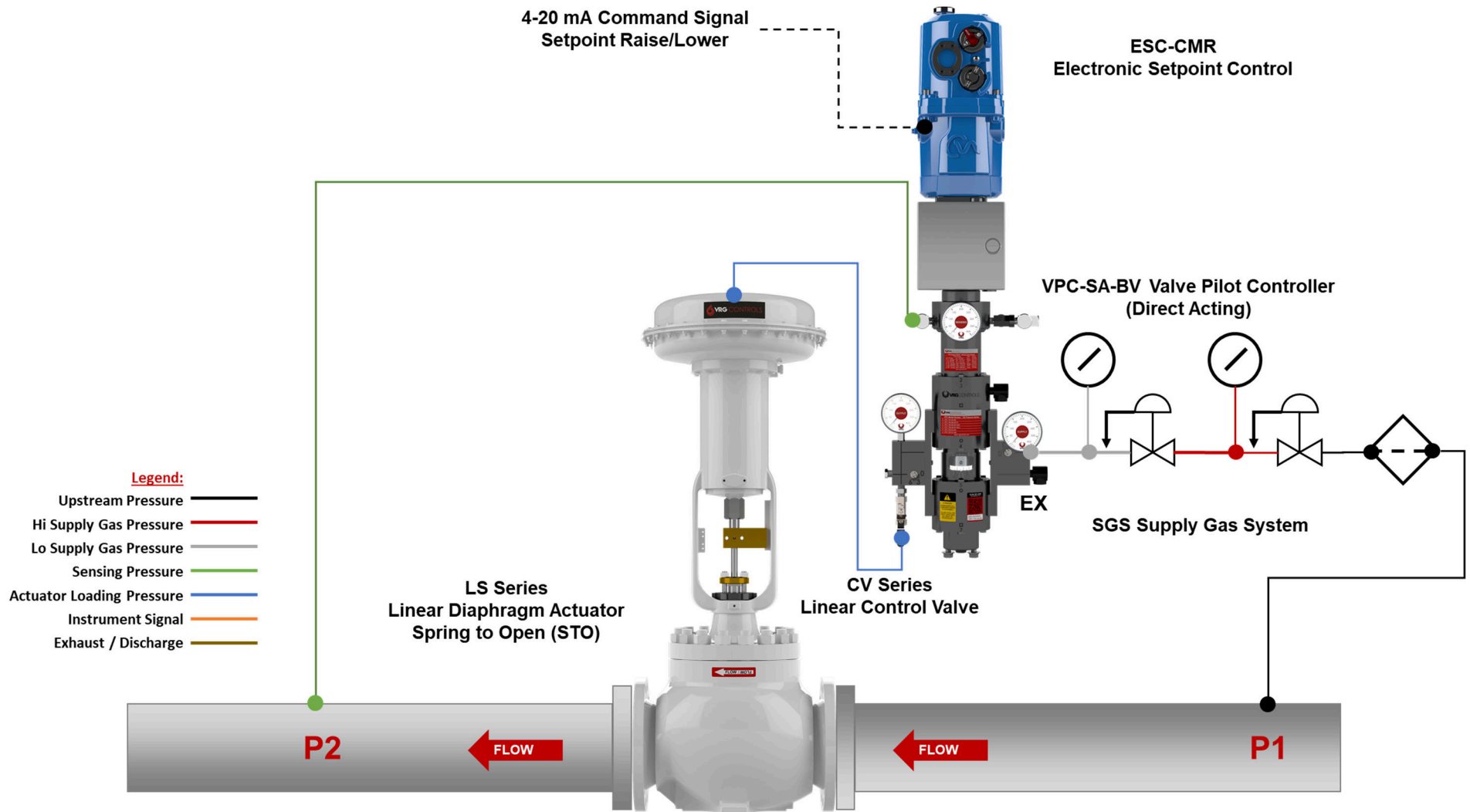

VPC Schematic #5 – VPC-SA-BV + ATM Ex – RHPA-SR

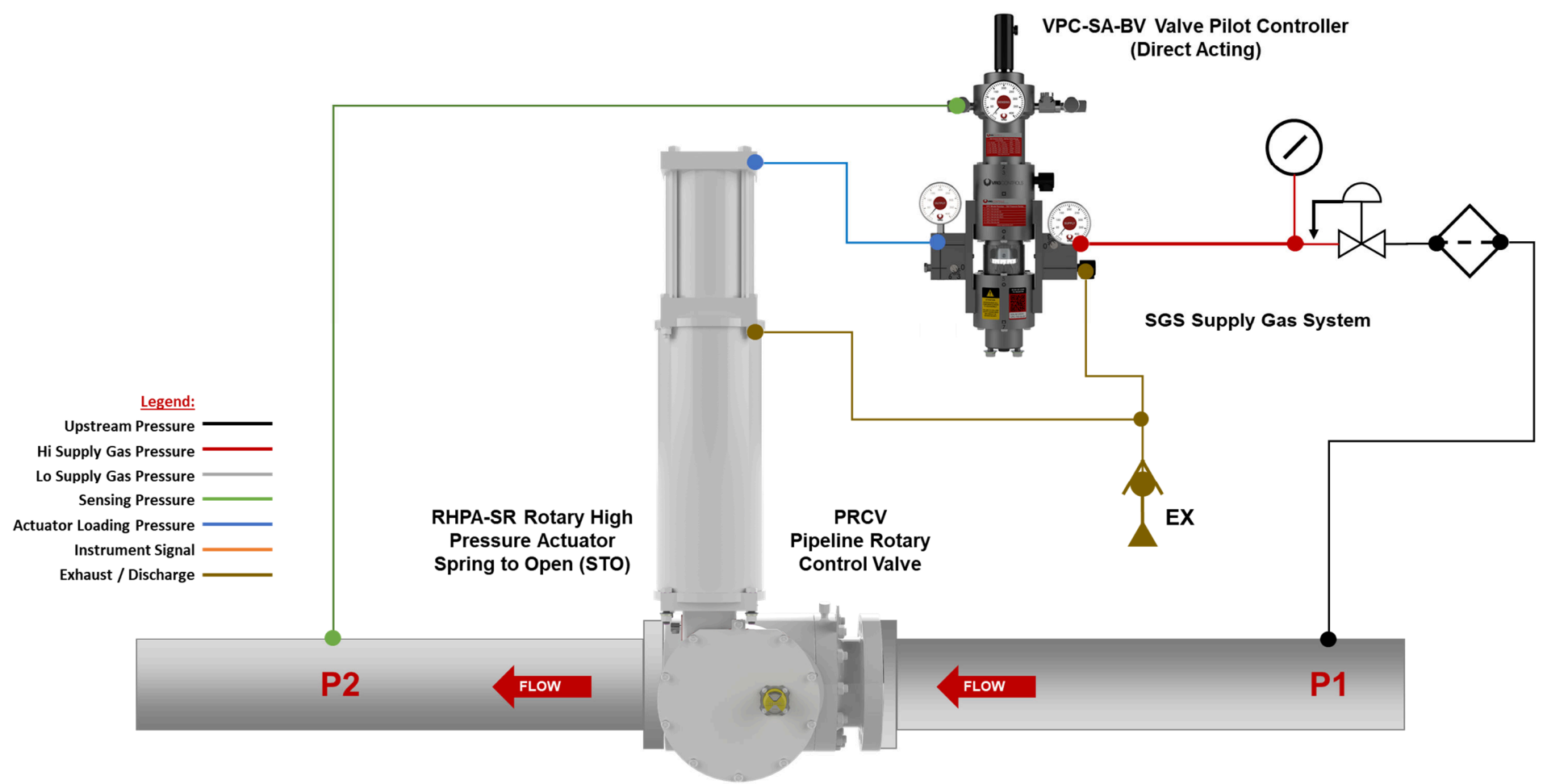

VPC Schematic #6 – VPC-SA-BV + ATM Ex – RHPA-SR

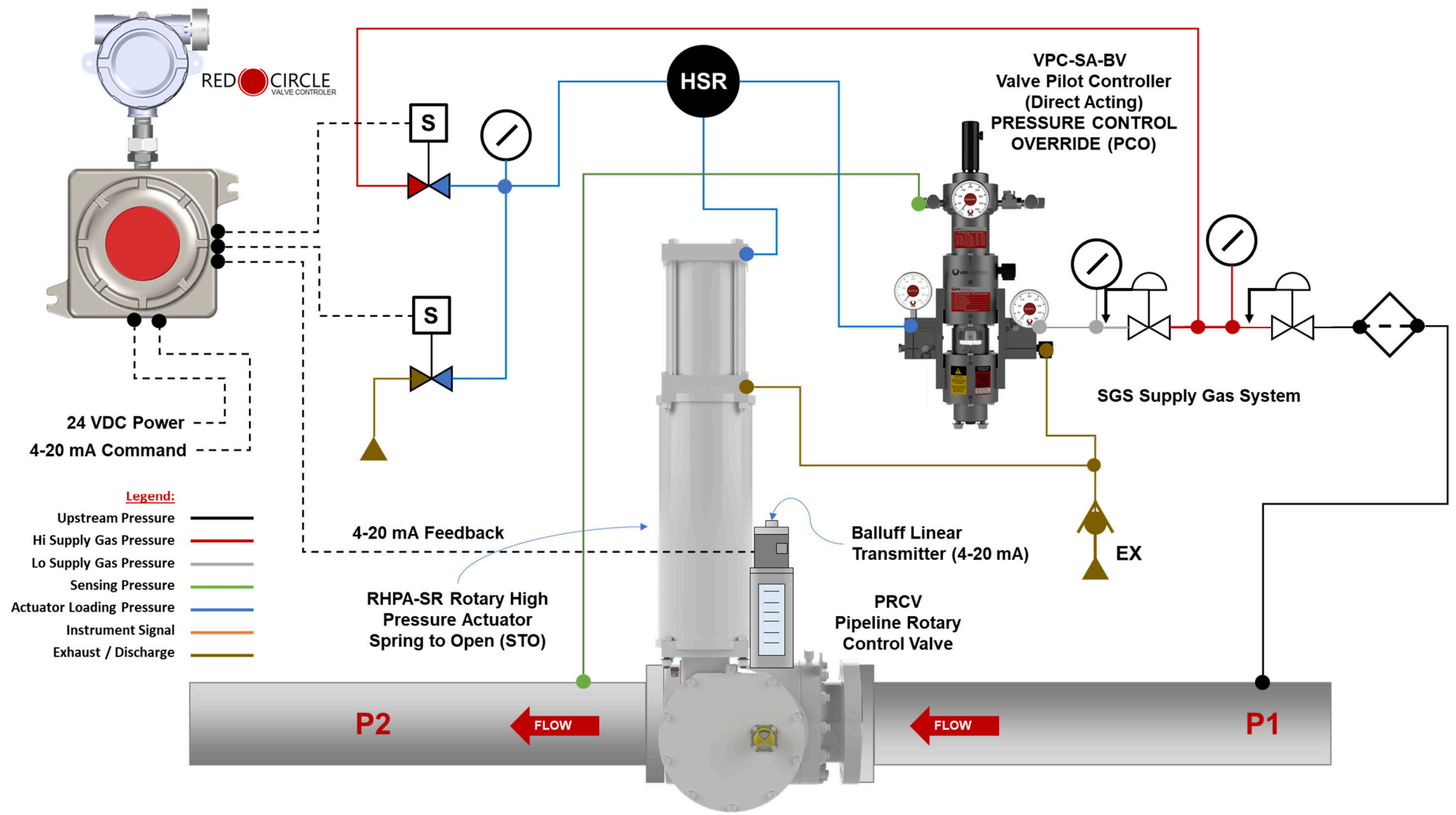

VPC Valve Pilot Controllers 30% More Accurate Than Competition

30% improved accuracy for the VRG controller versus the legacy brand controller:

- **VPC Sensing Diaphragm 18% Larger than Competition = Increased Sensitivity**
- **VPC Control Spring K-Factors Lower Resulting = Increased Sensitivity**
- **Control Springs are Precision Ground to Ensure Free Travel = Increased Sensitivity**
- **VPC New BV Seat Profile Improves Response = Increased Sensitivity**
- **VPC Mechanical Stops to Prevent Damage to Seat / Nozzle Assemblies**

<u>Performance Criteria</u>		<u>Legacy Brand</u>	<u>Notes</u>
Full Output Pressure	± 2.0%	± 3.0%	Percent Max Control Spring Range
Control Accuracy	± 0.5%	± 0.75%	Percent Max Control Spring Range

New BV Seat Design Improves VPC-BV Sensitivity

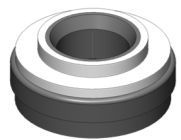

NEW BV Seat Design $\pm.52\%$ Guaranteed ($\pm.26\%$ Probable)



OLD BV Seat Design $\pm.73\%$ Guaranteed ($\pm.37\%$ Probable)

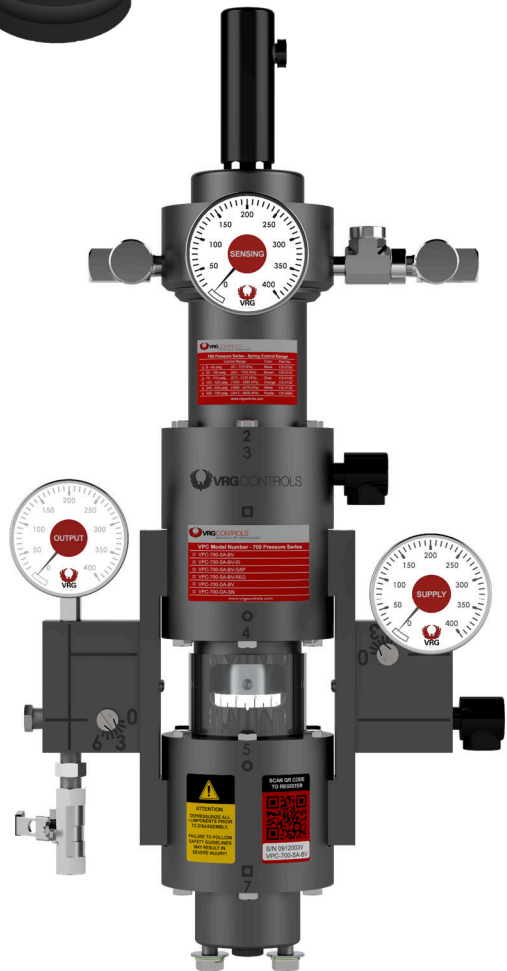

VPC-SA-BV

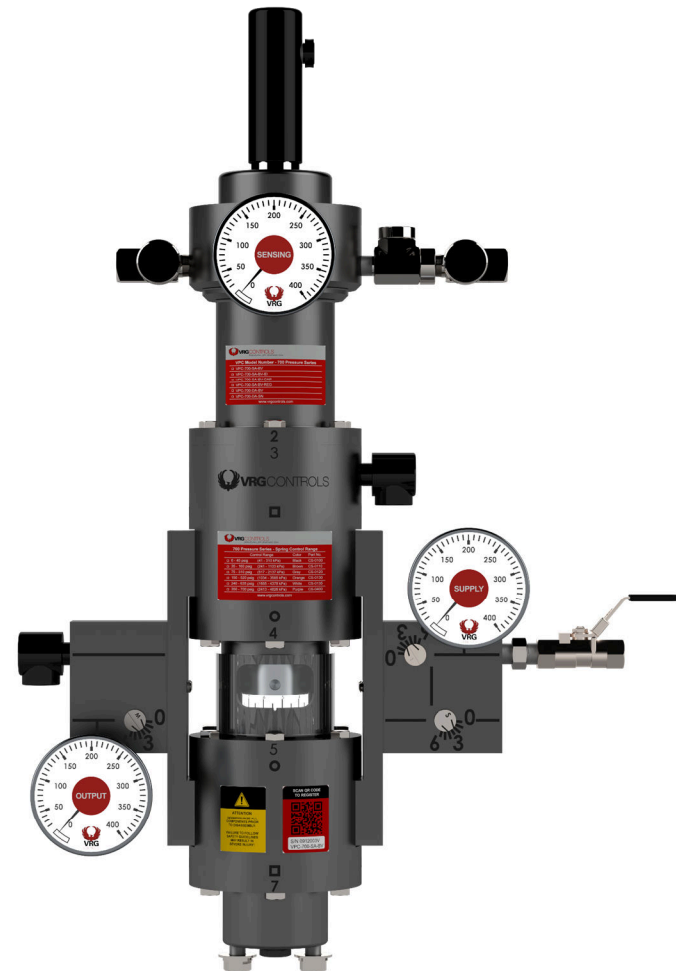

VPC-SA-BV-ID

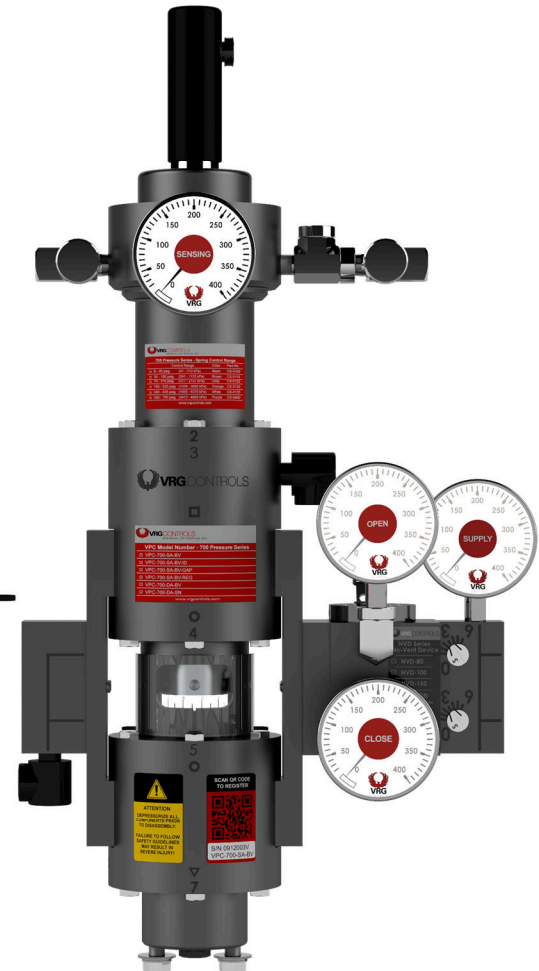

VPC-DA-BV

New Improved Balanced Seat – Increased Performance + Stainless Steel

NEW BV Seat Design (Stainless Steel)

(PD-0247)

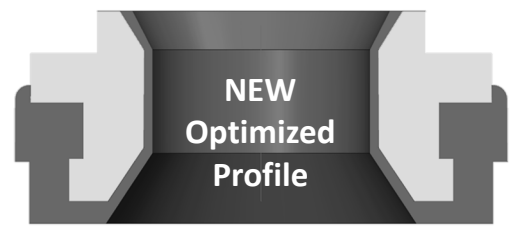
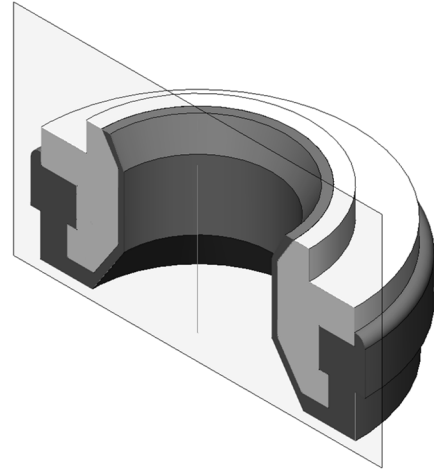
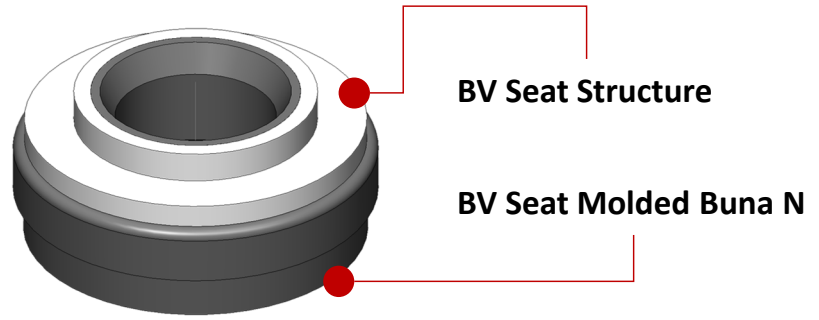

**** PATENT PENDING ****

OLD BV Seat Design (Brass)

(PD-0240)

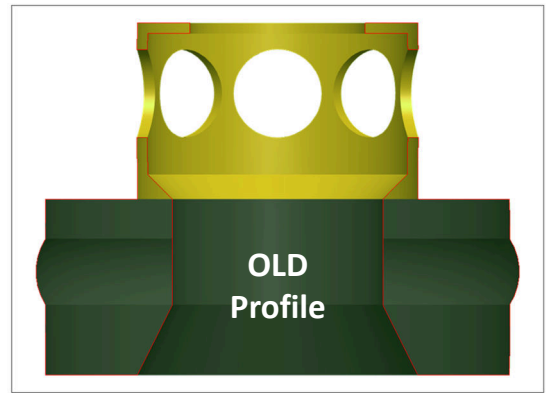
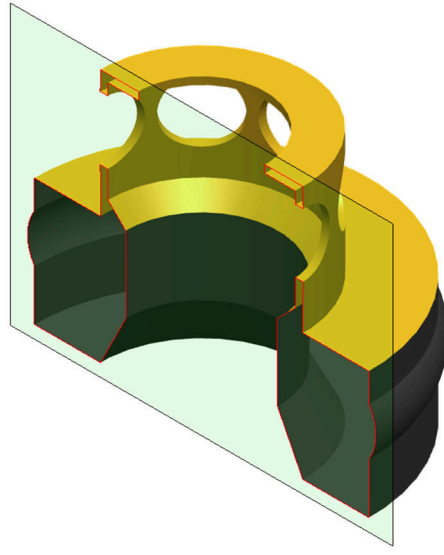
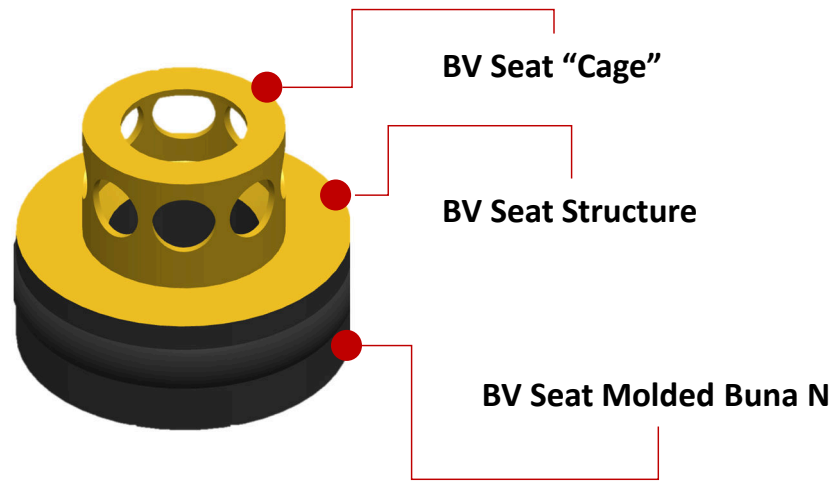

Quick Exhaust Monitor Design

Versa Model QE-3-316
Quick Exhaust Valve

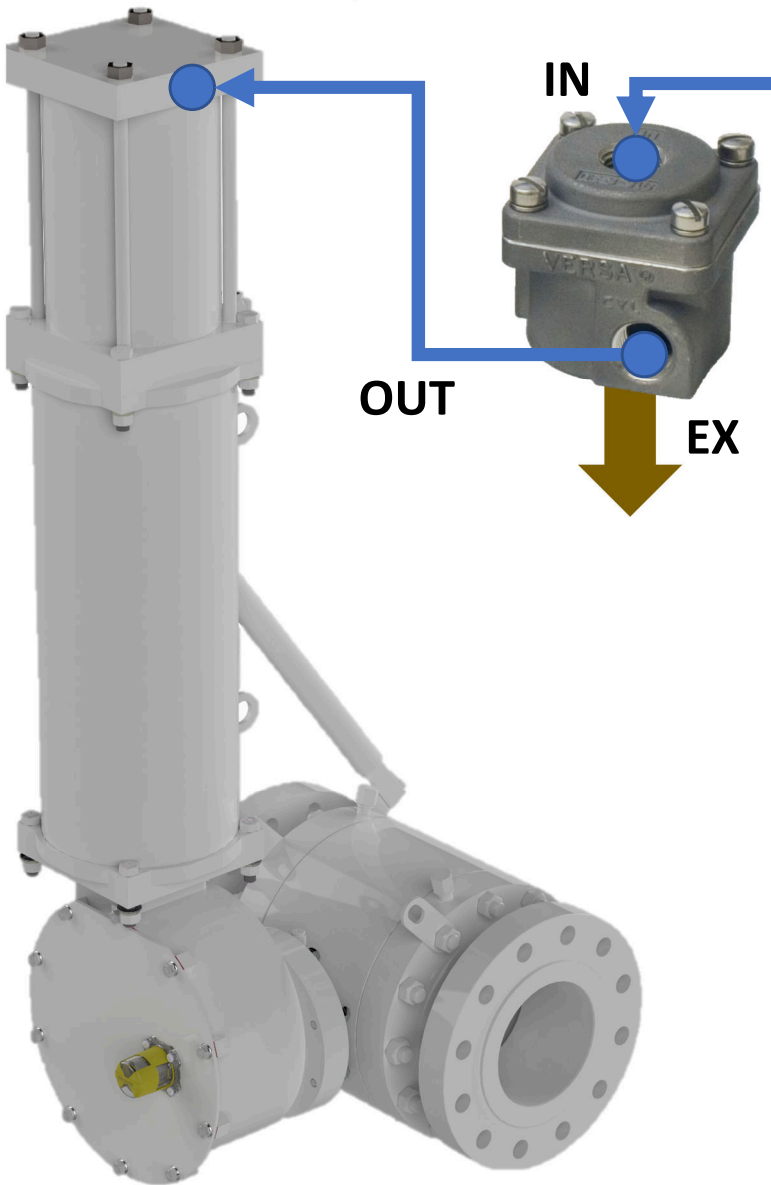

- Provides Rapid Response of Monitor Control Valves
- Use VPC-SA-BV and Spring Return Actuators
- Simple & Cost Effective
- Easily Retrofit to Existing Installations

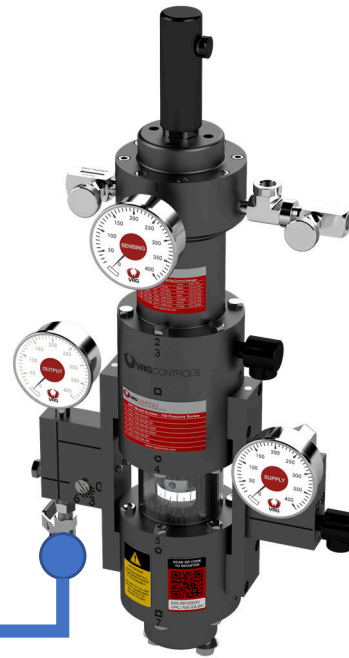

VPC Valve Pilot Controllers

Application Photo



Louisville Gas & Electric (LG&E)
CVET Globe Control Valves with VPC Valve Pilot Controllers w/ VMO



VPC Valve Pilot Controllers



Application Photo



**VPC Controllers fitted to Pressure Control Panel
w BP Sensors and VMO Valve Manual Overrides.**

**System operating in tandem with Mokveld
double acting control valves in UK AGI w SGN
Southern Gas Networks.**

All product PED, CE and ATEX Compliant.

Customer: SAITH



SGN
Your gas. Our network.

VPC Valve Pilot Controllers

Application Photo



Remote Control of VPC Pilots via ESC Motor. 4-20 mA Command Signal provides proportional adjustment of setpoint. Loss of electrical signal or communication renders system to control in last setpoint. System will not lose control in event of loss of electrical.

Application Photo

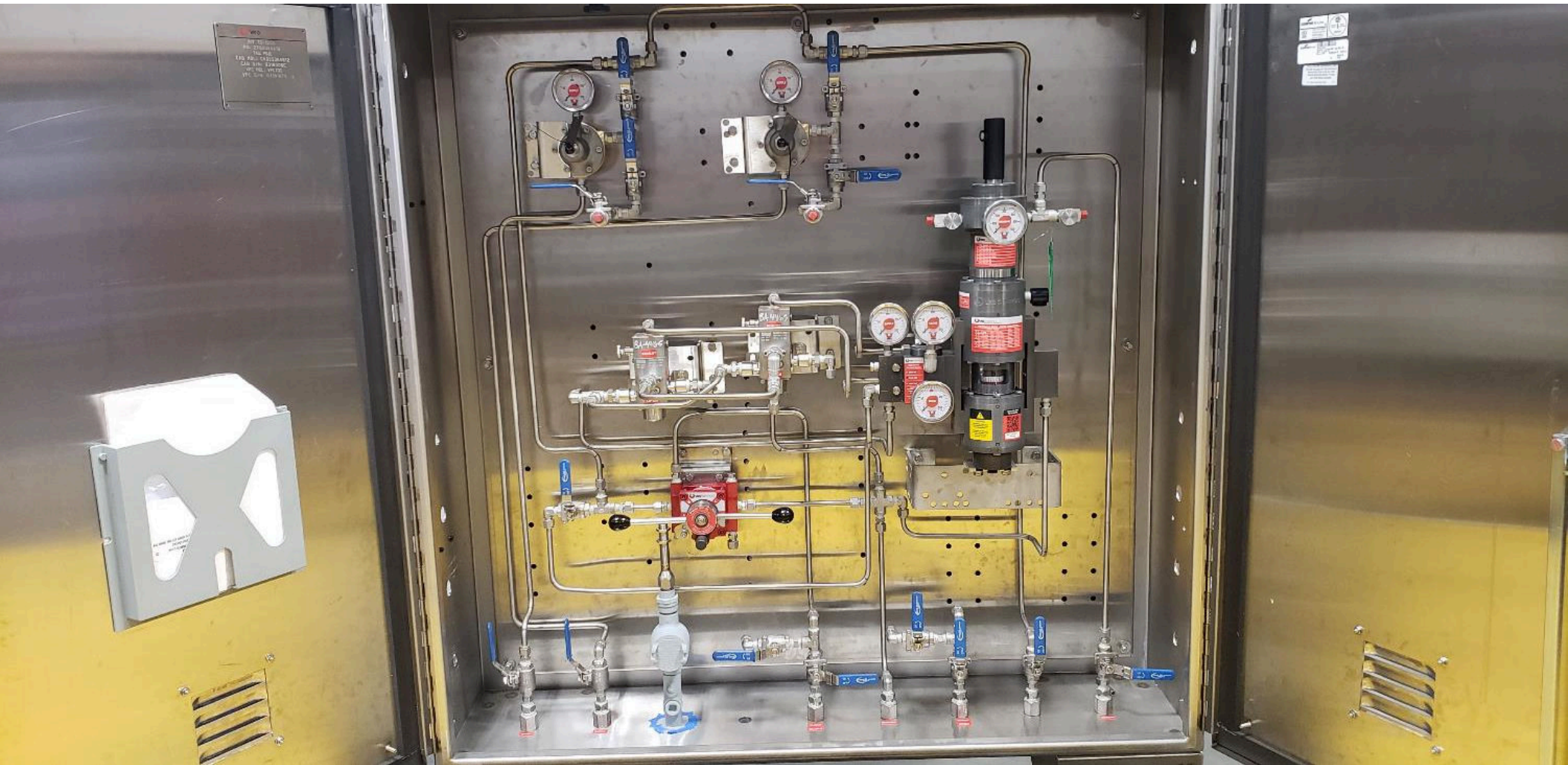

Stainless Steel Control Cabinet with VPC-700-DA-SN Valve Pilot Controller and Volume Boosters. System configured to provide Monitor Overpressure Protection in tandem with a large bore control valve with double acting pneumatic actuator. System installed on gas distribution utility in central California, USA.

Application Photo



Stainless Steel Control Cabinet with VPC-700-DA-SN Valve Pilot Controller and Volume Boosters. System configured to provide Monitor Overpressure Protection in tandem with a large bore control valve with double acting pneumatic actuator. System installed on gas distribution utility in central California, USA.

Application Photo

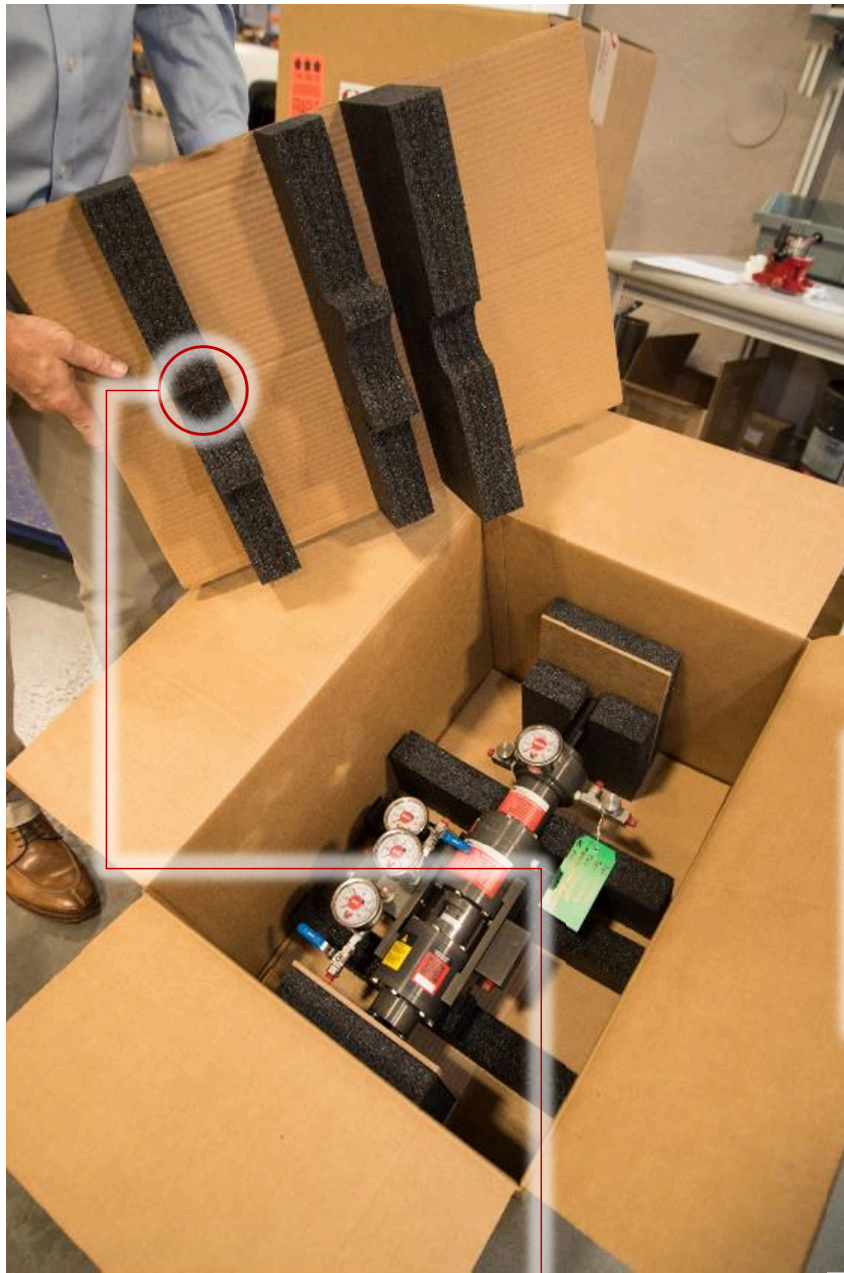

VPC Valve Pilot Controllers

Foam Suspension System
Cradles All VPC Models



Foam Tab System
Captures Brackets
and Accessories

Application Photo



Typical Spring Return (Single Acting) Control Valve equipped with VPC-700-SA-BV for pressure control. Control Valve will travel to full closed position in event of loss of supply gas pressure.

Application Photo



VPC Valve Pilot Controllers ready for shipment to client in Italy. Italian Gas Utility has identified all high emission pneumatic pressure controllers and is replacing all units with VRG Controls VPC Valve Pilot Controllers. VPCs are PED, CE and ATEX Compliant for use in EU.

Our Contact Information

VRG Controls, LLC

Toll-Free: +844-FLOW-VRG (USA & CANADA)

e-Mail: Sales@VRGControls.com

www.VRGControls.com

VRG Controls, LLC

1199 Flex Court, Unit B

Lake Zurich, Illinois 60047 USA



VRG Controls, LLC

Solutions for Natural Gas!

Follow Us:

