



THERMAL MASS FLOW MEASUREMENT FOR GASES



Sage Metering:
*Pioneers of the In-Situ Calibration
Verification Procedure*



A Commitment to Higher Performance

SAGE METERING is a manufacturer of high performance Thermal Mass Flow Meters which measure the flow rate and consumption of gases for multiple industrial, municipal and commercial applications. Frequently used for energy management systems to monitor and improve energy efficiency as well as for regulatory compliance in environmental systems including carbon credit verification and flare gas monitoring.

TYPICAL APPLICATIONS include measurement and sub-metering of natural gas and compressed air for energy utilization and cost accounting within an industrial facility. Measurement of combustion air flow can be used for improving efficiency in boilers and furnaces. Monitoring of gas lines in campus or university building locations to assess energy inefficiencies. Institute conservation measures as appropriate.

OTHER KEY environmental applications include flare gas flow measurement in the Oil and Gas Industry, as well as leak detection, where Thermal Mass Flow Meters offer economic advantages over traditional flow measurement technology. To meet the regulatory requirements of periodic re-calibration or calibration verification, Sage Metering has developed a unique in-situ accuracy verification process to ensure the meter is performing within the original NIST traceable gas calibration while the process remains in operation.

Sage Meters are used for all types of applications:

ENERGY MANAGEMENT

- Natural Gas Measurement
- Compressed Air Flows

ENVIRONMENTAL

- Aeration Flow
- Greenhouse Gas Emissions
- Carbon Credits
- Flare Gas
- Biogas / Landfill Gas

PROCESS

- Combustion Air
- Drying Air Flow
- Vent Air
- Boiler/Furnace Optimization

FACILITIES MANAGEMENT

- Natural Gas Sub-metering
- Department Cost Allocation
- Leak Detection

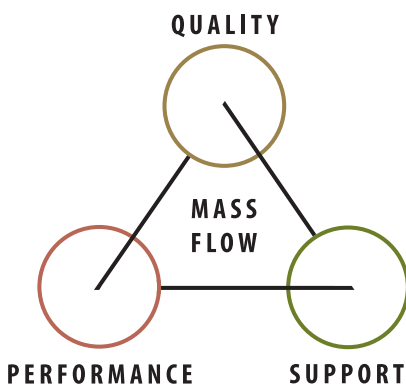

Experience and Expertise

SAGE METERING, INC. is one of the fastest growing Thermal Mass Flow Meter manufacturer in the industry. Founded in 2002, Sage brings together individuals with many years of combined experience in the design, operation, and application of Thermal Mass Flow Meters. This vast knowledge has enabled Sage to identify and improve on the overall design and performance of Thermal Mass Flow instrumentation. Sage's philosophy is inherent throughout its product line and services.

- Innovative Products
- On Time Delivery
- Extraordinary Customer Service
- Strong Commitment to Quality
- Excellent Responsiveness to Customers

Make the Wise Choice. Choose Sage Flow Meters.

A Pioneer in Technology Development

SAGE METERING has brought to market the first hybrid digitally-driven circuit design, eliminating the traditional analog Wheatstone bridge. This feature has provided Sage products with the ability to:

- Eliminate analog drift, improving stability and long term reproducibility
- Show a reproducible zero flow point, permitting simple and reliable calibration verification
- Maintain higher resolution providing greater rangeability
- Digitally-driven temperature sensor eliminates self-heating errors
- Match overheat to application for greater signal resolution
- Remote Style: up to 1000 ft. from probe, and lead-length compensated (junction box has no circuitry – suitable for harsh environments)

IN-SITU CALIBRATION VERIFICATION

- User can easily verify that flow meter remains in calibration with simple field test while process is in operation
- Checks overall instrument performance – both sensor and electronics
- Eliminates the need for periodic factory re-calibration
- Meets regulatory requirements for calibration check

FIRST GRAPHIC DISPLAY IN THERMAL FLOW INDUSTRY

- Provides flow rate, temperature, totalized flow, diagnostics, and signal at a single glance
- High contrast display easily readable, even outdoors

IMPROVED TEMPERATURE COMPENSATION

- Ensure accurate flow measurement over wide range of process temperatures

ATTENTION TO ACCURACY

- Calibrations performed on actual gas in closed-loop facility
- NIST traceable calibration facility provides accuracy flexibility

NIST Traceable Calibration



Compact Design



Durable Construction



High Velocity NIST Calibration Facility



Sage Paramount™ Industrial Thermal Mass Flow Meter (400 Series)

The new Sage Paramount™ Industrial Thermal Mass Flow Meter provides state-of-the-art components, a dual-sided, explosion-proof, NEMA 4X enclosure (Div. 2 rating), a fast response to rapid temperature fluctuations, and a well-thought-out terminal arrangement with a 3-way switch for externally, or internally isolating the 4-20 mA or for non-isolated self-powered operation (see photo below).

One of the many compelling features of the Paramount™ is its accompanying free software, SageCom™. The SageCom™ software effortlessly connects the Sage Paramount™ to your PC via a separate mini USB connector¹ (cable supplied) located within the back terminal enclosure. This connector is independent of the normal Modbus communication channel allowing validation or reconfigurability of your Paramount™, even while it's standard Modbus output is connected to a network of additional Paramount meters going to the SCADA system.

The innovative features of the new software permits the user to reconfigure the meter (change full scale, change pipe size [4" or larger], modify engineering units, and more). Also, you can change common gas constituents in the field, log real-time data, perform a loop check on the plant's 4-20 mA, and validate the meter's operation through three different diagnostic steps, including the Sage In-Situ Calibration Verification. When finished, print a Validation Report, complete with time and date stamps (ideal for QC departments, ISO).



401
Insertion Probe shown with SVA05 Mounting Hardware

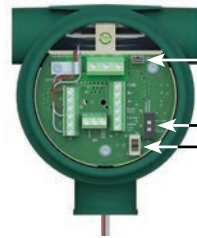

Separate USB Communication Channel
3-Way Switch for the 4-20 mA Output
On/Off Power Switch

Scan here for terminal details



Sage Prime™ Thermal Mass Flow Meter (SIP Series)

The Prime™ is Sage's long-standing Thermal Mass Flow Meter for all industrial and commercial applications. The Prime™ has been approved for use in hazardous areas by many agencies, plus CE rated for Electromagnetic compatibility.

Sage Prime™ has continuous diagnostics. The raw calibration milliwatts (mw) is always displayed in the upper left hand corner of the meter's display. At any time, you can check this reading at a "No Flow" (0 SCFM) condition, and compare the reading to the original reported "No Flow" value noted on the last few lines of your meter's Certificate of Conformance or the Flow Meter's data tag. This in-situ diagnostic procedure not only checks the sensor performance and the "Live Zero" calibration point, but it also verifies that the sensor is clean. It essentially provides a means to validate that the meter is operating properly, verifies that there is no shift or drift, and eliminates the need for annual factory calibrations. This simple field diagnostic procedure, in addition, verifies that the sensor is free from contamination, even without inspection.



SIP Insertion Probe

Remote Style of Paramount™ or Prime™

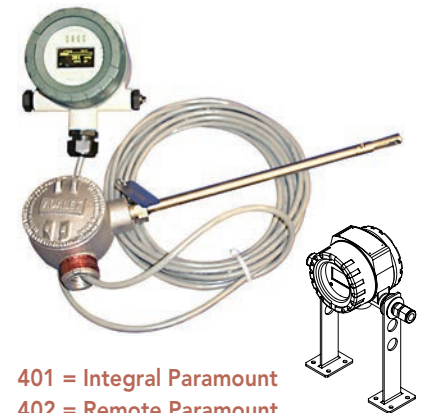

401 = Integral Paramount
402 = Remote Paramount
SIP = Integral Prime
SRP = Remote Prime
(Shown in above photo)

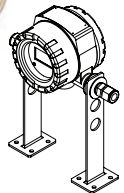

Mounting Hardware Included

MEASURING SPECIFICATIONS OF PARAMOUNT™ OR PRIME™	
Flow Accuracy	+/-0.5% of Full Scale +/-1% of Reading over a 100:1 Turndown
Turndown	100:1
Resolution	1000:1
Flow Repeatability	0.2%
Flow Response Time	1 second time constant (e.g. responds to 63% of a step change each second)
Special Accuracy	With limited turndown, custom accuracy available
Low End Sensitivity	5 SFPM

¹Second communication channel via a mini USB connector (cable supplied) on Paramount™ only (features ability to have Modbus via USB connector and Modbus or optionally HART™ off of the terminals)

ELECTRONICS AND OUTPUTS OF PARAMOUNT™ OR PRIME™	
Power Supply	24 VDC (18-28 VDC) or optional 115/230 VAC or 12 VDC with less approvals (Prime only)
Power Consumption	2.4 Watts Maximum
Flow Output	4-20 mA proportional to Gas Mass Flow Rate (0-100% Full Scale = 4-20 mA) internally powered; or customer selectable externally powered and isolated 4-20 mA
Totalizer (Pulsed Output)	24 VDC Pulse for Totalized Value Pulse Width (minimum 50 mSec) and Pulse Rate configurable (e.g. 10 SCF/pulse, etc.)
Relay Output	Available Externally (specify DCR-DC): SPDT 10 Amp contacts; activated from pulse
Communications ¹	Modbus compliant RS485 RTU (19200 baud [default] or 9600 baud) or optional BACnet. HART™ is optional on Paramount™ only.
Temperature Output	Through Modbus or SageCom™ software program
mW output (raw calibration data)	Through Modbus or SageCom™ software program

All 24 VDC Powered Sage Paramount™ and Prime™ Meters are approved for Class 1, Div. 2, Groups B, C, D, T4, UL/CSA, ANSI 12.12.01, ATEX: Ex nA IIC T4, and CE

SageCom™ Validation and Configuration Software

SageCom™ is a new, powerful, yet easy to use software program which gives the user testing, diagnostics, performance verification and local configuration capabilities for our family of Sage Thermal Mass Flow Meters. This new software permits the user to easily perform a variety of diagnostic tests, offering reassurance that the Sage Flow Meter is performing per the original specifications.

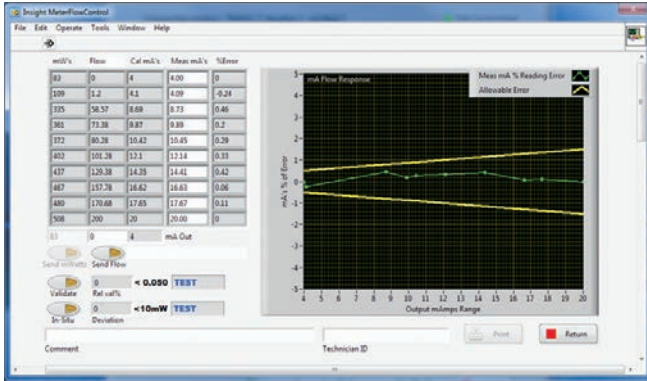

10 point loop evaluation

Software Diagnostics

- Verify that the flow meter is within original calibration and that the sensors are clean
- Confirm that the flow meter is measuring flow based on the original factory calibration and that the linear output signal is correct
- Print a Validation Report

Software Reconfigurability

- Check or change the configuration of the instrument, such as changing full scale, pipe size, engineering units or decimal points

Change Gas Mix in the Field

- Enter an entirely new set of common gas mix constituents versus the original calibrated mix, and the meter will automatically correct its readings to the new mix

Log Real-Time Data

- Real-Time tab logs data which is easily exported to Excel

Sage 200 / 300 Thermal Mass Flow Meters

The Sage 200/300 Series™ Flow Meters provide the same high level of performance as the Sage Prime only with a more economical offering.

For more information on the Sage 200/300 Thermal Mass Flow Meters, view the Products Tab on the Sage website by visiting: www.sagemetering.com

Agency approved for Class 1 Division 2 service

4-20 mA and pulse output

Optional Modbus output

Optional display of flow rate, total flow and temperature



Sage 300™ Meter shown with Insertion Probe



For more information on the Sage Prime (above) or Prime HVAC, view the Products Tab on the Sage website by visiting www.sagemetering.com/prime. Or contact Sage at 866-677-SAGE (7243).

Sage Rio Thermal Mass Flow Meter (SIX Series)

The Sage Rio™ Thermal Mass Flow Meter provides the same levels of performance found in the Sage Prime™ with additional agency approvals.

ATEX Flameproof approval –
 Ex II 2G Ex d IIB+H2 T6 Gb*
 UL, cUL for Class I, Div. 1, Groups B, C, D

Available with Integral (SIX) electronics. Remote style (SRX) optionally available

1/4" to 4" flow body with flow conditioner (NPT standard, flange optional)

Rotatable graphic display gives flow rate, totalized flow, temperature and diagnostics information

Outputs:

- 4-20 mA
- Modbus
- Optional HART™
- Pulse
- Optional BACnet

In-situ calibration check verifies proper operation of flow meter

*T6 Rating is suitable for gases with ignition temperature as low as 185°F (85°C)



Sage Rio shown with Insertion Probe

For more information on the Sage SIX (above), view the Products Tab by visiting www.sagemetering.com/rio. Or contact Sage at 866-677-SAGE (7243).

Flow Conditioning

Any insertion flow meter measures the flow at the location of the sensor. Therefore the overall accuracy of the flow measurement is dependent on the flow profile in the pipe.

With sufficient amount of straight pipe run, the desired flow profile naturally occurs. Sage recommends straight run distances which are dependent upon upstream and downstream pipe configuration. These recommended distances provide the expected flow profile at the sensor.

Often the desired amount of straight run is not available. In these situations, Sage Metering offers flow conditioning assemblies. They are easily installed between two flanges as shown to the right. When using a flow conditioning assembly, the recommended upstream straight run is greatly reduced. The use of a flow conditioner is a very simple method for obtaining the best possible overall accuracy.

Note, Sage in-line flow meters (1/2" and up) include built-in flow conditioners, thus minimizing the amount of upstream straight run that is required.

Typical Sage Flow Meter Installation Following a Single 90° Elbow without Sage Flow Conditioning

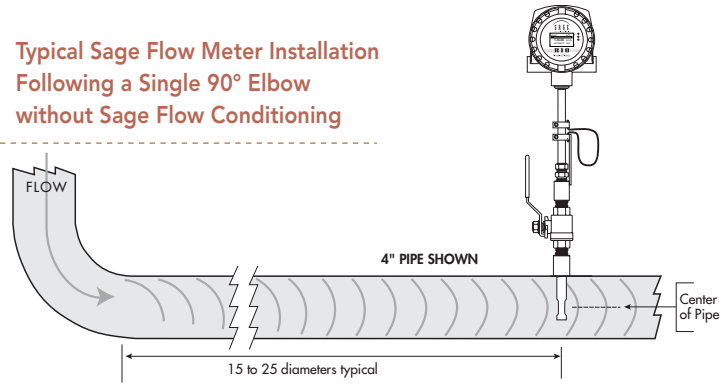

Typical Sage Thermal Mass Flow Meter Installation with Flow Conditioner Assembly

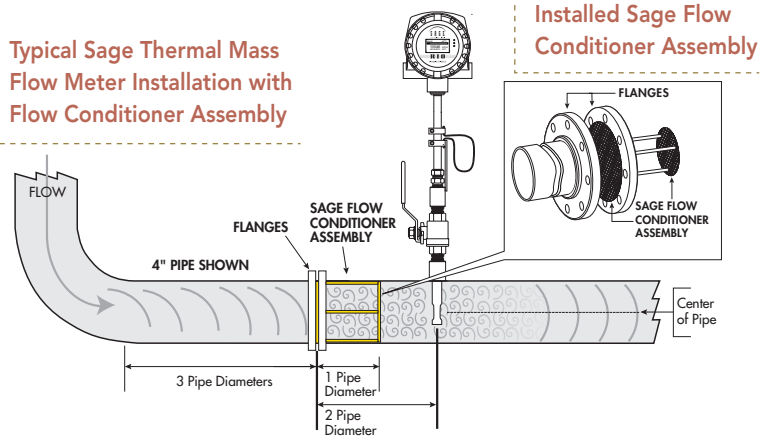

Sage Sensor Design

Sage offers the sensor in two different designs. The standard 1/2" diameter probe for general purpose use and the new 3/4" all welded design for heavy duty industrial applications, as well as ultra high velocity applications (35,000 SFPM; or up to 60,000 SFPM with reduced accuracy).

Installation Hardware

The Sage Flow Meter with insertion probe can easily be installed into a pipe or duct by using a 1/2" or 3/4" NPT connection for the 1/2" probe or a 1" NPT for the 3/4" probe. The two most common methods of installation are the SVA isolation valve with a compression fitting or the simple STCF compression fitting. The compression fittings have Teflon ferrules which provide ease in installation and positioning the sensor. The use of the isolation valve permits the probe to be removed while the process is in operation. Flange connections can also be provided to meet user's piping requirements.

PROBE LENGTH OF INSERTION PROBES

	STCF05/STCF07* Compression Fitting	SVA05LP Isolation Valve Low Pressure	SVA05/SVA07* Isolation Valve High Pressure
PIPE SIZE	<125 PSIG	<50 PSIG	<250 PSIG
1"–2.5"	6"	12"	15"/18"
3"–4"	6"	12"/15"	15"/18"
6"–10"	12"	18"	18"/24"
12"–14"	12"	18"	24"
18"–24"	15"/18"	24"	24"/30"
30"–36"	24"	30"	36"

*Use SVA05 for 1/2" diameter probe and SVA07 for 3/4" diameter probe and sensor

Flow Sizing

The two most common applications for Sage Flow Meters is for measurement of air and natural gas. The following charts indicate the Maximum Full Scale Flow Rates for these gases in different pipe sizes (see below for Minimum Full Scale Flow Rates).

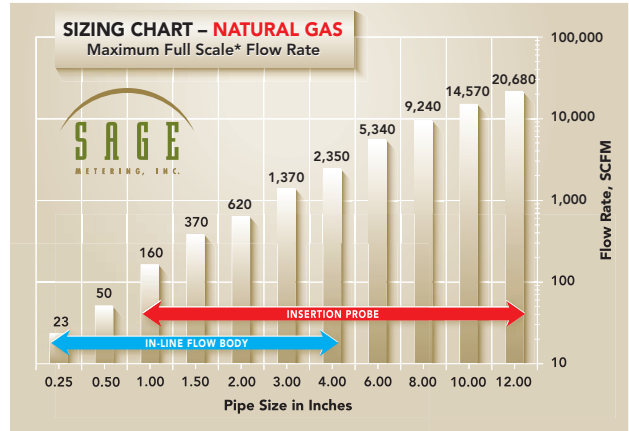
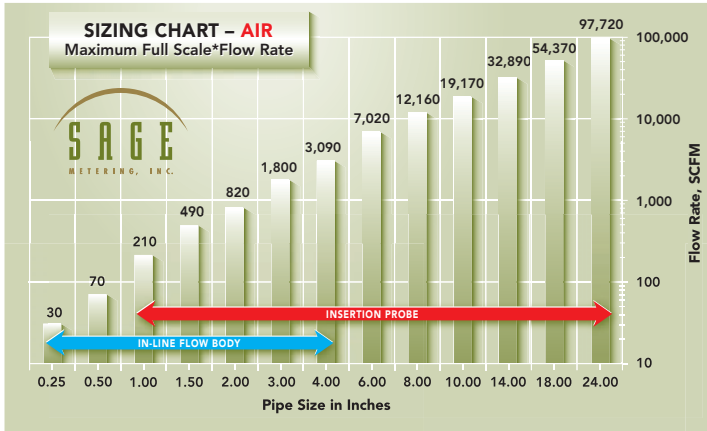

Full Scale Flow Rates of Common Gases Based on Pipe Size in Inches. Minimum Full Scale Flow Rate can be as low as 5% of Maximum Full Scale Flow Rate and will still maintain a 100:1 turndown. The accuracy of +/-0.5% of Full Scale +/-1% of Reading applies over the full turndown. All calibrations begin at no flow (0 SCFM).

Principle of Operation

Sage Thermal Mass Flow Meters measure heat transfer as the gas flows past a heated surface. Two platinum RTD sensors are clad in a protective sheath. The flow sensor is self-heated while the second sensor measures the temperature of

Sage Thermal Mass Flow Technology Uses Dual Temperature Sensors to Measure Flow Rate

the gas. As gas flows past the heated flow sensor the gas molecules carry heat away from the surface. The Sage proprietary sensor drive circuit replenishes the lost energy by heating the flow sensor to maintain the desired temperature difference over the entire temperature range of the instrument. The power required to maintain this temperature differential is proportional to the mass flow rate. The inherently non-linear signal provides excellent low flow sensitivity and high turndown capabilities. The signal is linearized to provide the output signal from the flow meter.

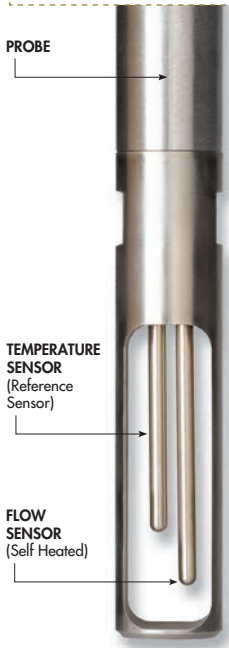

The Sage proprietary sensor drive circuit replenishes the lost energy by heating the flow sensor to maintain the desired temperature difference over the entire temperature range of the instrument. The power required to maintain this temperature differential is proportional to the mass flow rate. The inherently non-linear signal provides excellent low flow sensitivity and high turndown capabilities. The signal is linearized to provide the output signal from the flow meter.

is linearized to provide the output signal from the flow meter.

Calibration

Calibration is an essential portion of any thermal mass flow meter. The calibration establishes the

relationship between mass flow and the power required to maintain the specified temperature difference. For best accuracy, calibrations are performed on the actual gas in Sage's NIST traceable calibration facility.

In-Situ Calibration Verification

One of the challenges with any thermal mass flow meter is to verify the instrument's calibration. This is possible on the Paramount™, Prime™ and Rio™ if just one of the calibration data points can be checked during normal operation. Sage has developed a unique method which permits the user to verify the calibration without having to shut down or remove the sensor from the process. This "in-situ" process is accomplished in three easy steps – **Loosen, Lift, and Look** (see below). This permits the

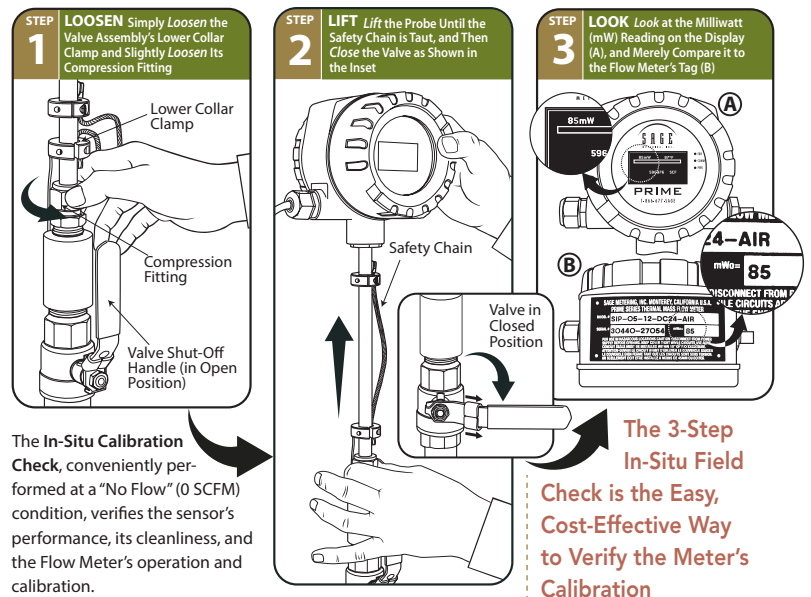

user to obtain a "no flow" data point which can be compared against the original factory calibration listed on the name plate and on the calibration certificate. When the measured signal matches the original NIST-traceable calibration data, the accuracy of the entire range of the meter is verified. For more information visit www.sagemetering.com



***Make the Wise Choice.
Choose Sage Flow Meters.***



Scan for Website

8 Harris Court, Bldg D / Monterey, CA 93940
866-677-SAGE (7243) / TEL 831-242-2030 / FAX 831-655-4965

www.sagemetering.com



Scan for Sage Paramount™
Industrial Thermal Mass
Flow Meter Flyer



Scan for SageCom™
Validation and
Configuration Flyer



Scan for Sage Prime™
Thermal Mass Flow
Meter Flyer